

# LK Zone Control 2-way 24V (NC) (for large areas)

## DESIGN

The LK Zone Control is used in large temperature zones that have their own heating circuit manifold and where the number of under floor heating circuits exceeds that normally regulated by the LK Room Thermostat. The LK Zone Control consists of a two way control valve with a 1" connection as well as LK Actuator 24V NC.

The LK Zone Control is normally connected to LK Room Control S1 Basic with wired communication between the room thermostat and connection box. Alternatively, the LK Zone Control can be connected to LK Room Control ICS.2 with wired or wireless communication between the thermostat and receiver unit. The room control regulates the room temperature through LK's self-modulation technology.

The LK Zone Control valve can also be used as a loop valve for large flow circuits such as, on LK Group Manifold Qmax.

The LK Zone Control is also available in design with LK Actuator 24V for 0-10V control signal.

## REQUIREMENTS

The heating system must be equipped with a control system with outdoor reset controlled heat regulation where pre-shunting of the secondary flow occurs via the LK Shunt or similar. It is recommended that the circulation pump for under floor heating flow has automatic speed control with settings for constant pressure regulation.

Before assembly, the heating system must be carefully flushed and should not contain any impurities or additives that may damage the product.



## ASSEMBLY AGAINST LK MANIFOLD RF

The LK Zone Control is preferably assembled against the supply on LK Manifold. Refer to the following assembly examples where the LK Zone Control is located on the supply manifold and adjustment valve LK OptiFlow EVO II is assembled on the manifold's return. The Zone Control valve can easily be assembled with the accessory LK Joint nipple with loose nut in straight or angled design. Refer to the accessory list.

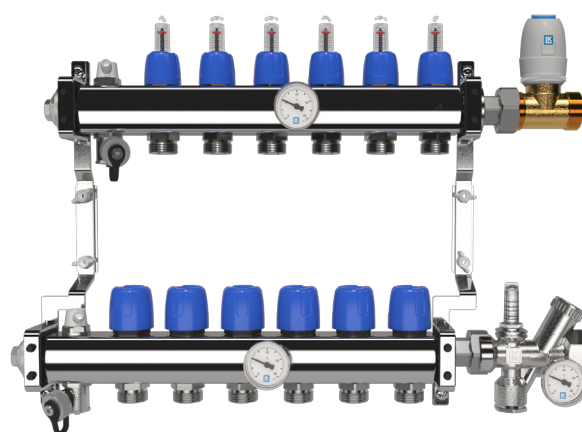

*LK Zone Control straight design right.*

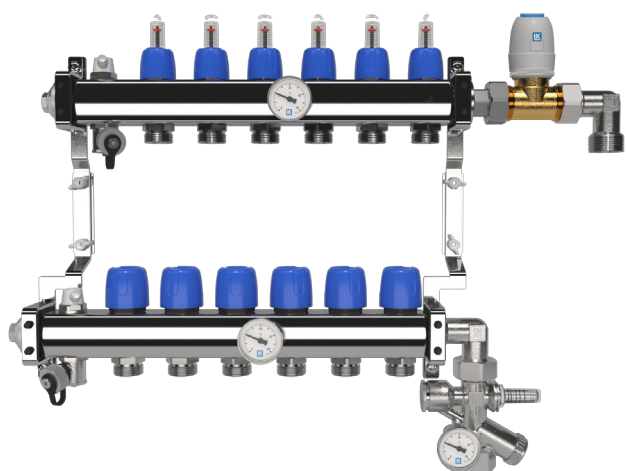

LK Zone Control angled design right.

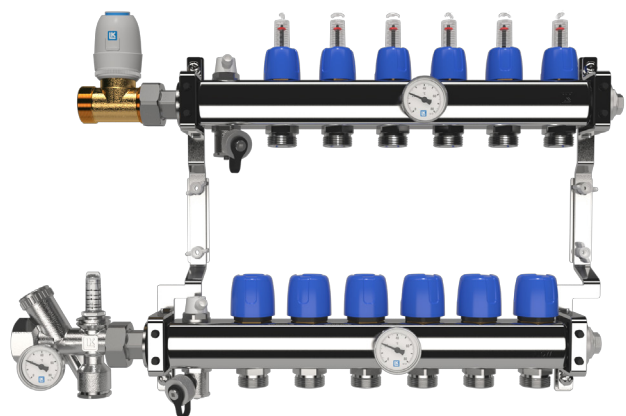

LK Zone Control straight design left.

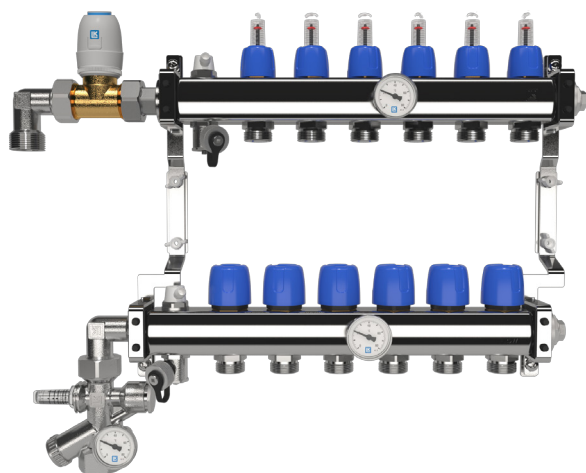

LK Zone Control angled design left.

### ASSEMBLY AGAINST LK GROUP MANIFOLD QMAX

In units with several under floor heating manifolds, all adjustment and manifold control is collected at one point in the unit. The piping feed for each manifold then originates from the LK Manifold Qmax.

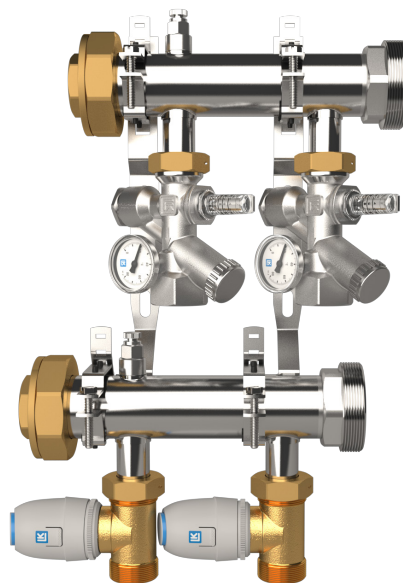

LK Zone Control against LK Manifold Qmax.

### FLOW DIAGRAM

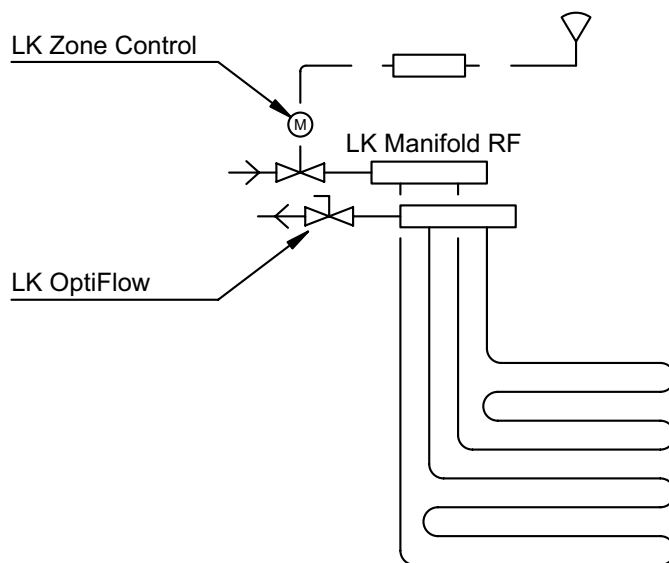

LK Zone Control against LK Manifold RF.

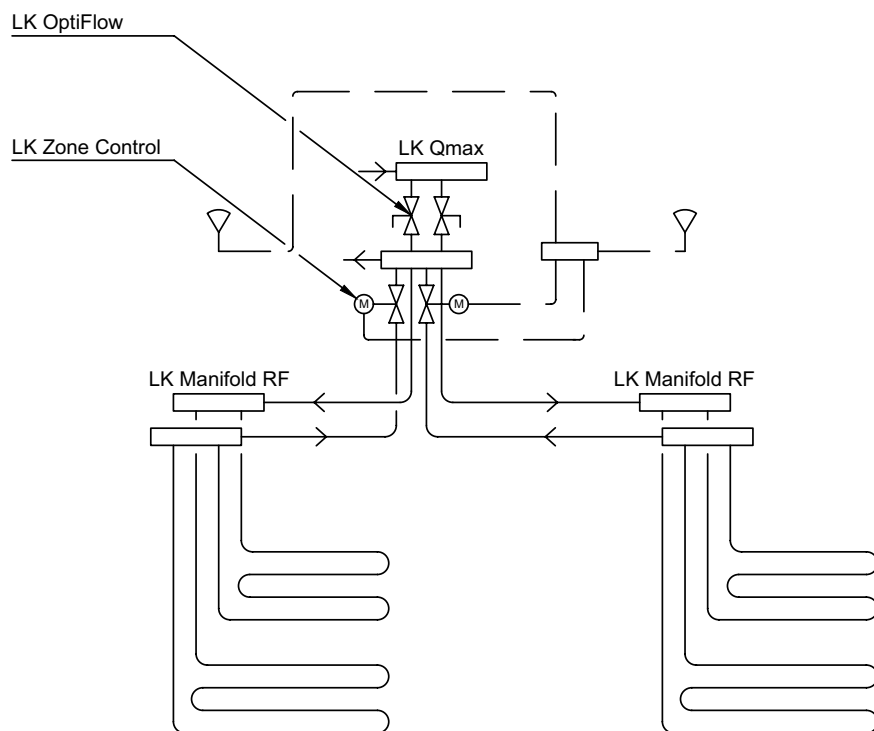

LK Zone Control against LK Qmax.

## ELECTRICAL CONNECTION

Electrical connection is done based on instructions for LK Room Control S1 Basic or LK Room Control ICS.2.

## TECHNICAL DATA

Article number	241 98 97
Supply voltage	24 V AC/DC NC (Normally closed actuator)
Output	2 W
Control valve	Kvs 4,5
Connection	1" male thread

- Recommended maximum flow 2000 l/hour, which provides a pressure drop of approx. 15 kPa over the valve.
- A maximum of 5 LK Zone Controls 24V NC can be regulated using the LK Room Thermostat S1 NC.
- A maximum of 5 LK Zone Controls 24V NC can be regulated via the LK Receiver 1 ICS.2.
- A maximum of 5 LK Zone Controls 24V NC can be regulated per channel via the LK Receiver 8 ICS.2, however maximum 12 pcs by receiver. A thermostat can control up to 8 channels; thereby it is possible for a thermostat to control up to 12 LK Zone Controls.

## ACCESSORY LIST

### LK Joint Nipple with loose nut

Art. no. 241 96 18	1" loose nut x 1" male thread straight
Art. no. 241 96 17	1" loose nut x 1" male thread angle

### LK Joint Nipple with loose nut, other

Art.no. 241 81 60	1" loose nut x3/4" male thread straight
Art.no. 241 94 57	1" loose nut x1/2" female thread straight
Art.no. 241 81 58	1" loose nut x3/4" female thread straight
Art.no. 241 81 59	1" loose nut x1" female thread straight

### Pipe connection with LK Half Coupler

Art. no. 241 81 64	1" x Cu22
Art. no. 241 81 65	1" x Cu28
Art. no. 241 81 66	1" x PE-X 25 x 2.3
Art. no. 176 90 06	1" x Cu22 B-Press

### LK Connection Set PE-X

Art. no. 241 81 10*	1" male thread/25 x 2.3 straight*
Art. no. 241 81 11*	1" male thread/32 x 2.9 straight*
Art. no. 241 81 12*	1" male thread/25 x 2.3 angle*
Art. no. 241 81 13*	1" male thread/32 x 2.9 angle*

\*Note! Supplement with joint nipple, Article no. 241 81 59.