

Zehnder ComfoBox Q

Technology and installation

zehnder

always
around you

Release 04.2021

Heating

Cooling

Fresh air

Clean air



Introduction

Please read this document carefully before planning the installation of the system.

This document has been prepared with the utmost care. However, no rights can be derived from this. In addition, Zehnder Group International AG reserves the right to change the contents of this document at any time without prior notice.

This document contains the specifications for the planning of a house system with Zehnder ComfoBox Series Q compact energy center. The document does not contain comprehensive information on the preparation and implementation of a comfort ventilation system, heating system, hot water system and geothermal heat source (earth probe, ground collector or other water heat source).

Product names

Zehnder ComfoBox Q compact energy center is usually briefly referred to as ComfoBox, nor is the exact type (e.g., power) referred to unless it is significant.

The comfort ventilation unit ComfoAir Q 450S, 450E, 600S, 600E is usually referred to briefly as ComfoAir when the exact type is irrelevant.

© The contents of this document are the intellectual property of Zehnder Group International AG. The acquisition of this document does not confer any rights on third parties to use patents or other intellectual property rights.

Comfosystems®, ComfoBox®, ComfoHeat®, ComfoAir® and ComfoTherm® are internationally protected trademarks of the Zehnder Group.

Document No: TM-CBQ_DE-CH V1.0 Issue 04.2021 (Author: MGR07)

Contents

Introduction	2
1 Design and function	5
1.1 Overview	5
1.2 Function diagram	6
1.3 Dimensions	7
1.4 Maintenance distances	8
1.5 Heating.....	9
1.6 Cooling.....	9
1.7 Ventilation	9
1.8 ComfoFond Q-Box.....	10
1.9 Water heating	10
1.10 Options.....	11
1.10.1 Swimming pool heating.....	11
1.10.2 Energy source, spring water, ground water	11
1.10.3 Solar water heating	11
1.10.4 Buffer tank.....	11
1.10.5 Hygiene container	11
1.11 Installation / interfaces	12
1.12 Offer text	12
2 Installation.....	13
2.1 Assembling ComfoBox Q.....	14
3 Connections	18
3.1 Overview	18
3.2 Connections	19
3.2.1 Thermal insulation of connecting pipes.....	19
3.2.2 Circulation pumps	19
3.2.3 Pump diagram ComfoBox 1-9	20
3.2.4 Pump diagram ComfoBox Q 3-12.....	21
3.3 Electrical connections	22
3.3.1 Wiring concept	22
3.3.2 Electrical connections	23
3.3.3 Electrical module terminal blocks	24
3.3.4 Wiring diagram option 1	25
3.3.5 Wiring diagram option 2	26
3.3.6 Wiring diagram option 3	27
3.3.7 Analogue inputs (AI) → Block I	28
3.3.8 Digital inputs (DI) → Block II	29
3.3.9 Analog outputs (AO) → Block II	30
3.3.10 Digital outputs (DO) → Block III, Block VI.....	30
3.3.11 Power supply to the heat pump	31
3.3.12 Power supply of internal emergency heating	31
3.3.13 ComfoTherm	32
3.3.14 Heat pump room control console	33
3.3.15 ModBus.....	34
3.3.16 ModBus protocol	35
3.3.17 Wiring of the electric heater of the hot water heater	38
3.3.18 Cable cross-sections.....	39
3.3.19 ComfoAir electrical connection.....	39
3.4 Wiring diagram.....	40
3.5 Connecting to air pipes	45
3.5.1 Dimensioning air pipes	45
3.5.2 ComfoAir Q450 power chart	45
3.5.3 ComfoAir Q600 power chart	46

4 Specifications.....	47
4.1 Zehnder ComfoBox Q specifications	47
4.2 ComfoBox Q 1-9 power chart	48
4.3 ComfoBox Q 3-12 power chart	49
4.4 Comfobox Q 1-9 pressure loss table	50
4.5 Comfobox Q 3-12 pressure loss table	51
5 ComfoBox integration concept.....	52
5.1 General information on integration options	52
5.2 Option 1 (direct circuit without buffer tank)	53
5.2.1 Option 1.....	53
5.2.2 Option 1 with swimming pool option.....	54
5.2.3 Option 1 with solar option.....	55
5.3 Option 2 (direct circuit, mixed circuit with buffer tank).....	56
5.3.1 Option 2	56
5.3.2 Option 2 with swimming pool option.....	57
5.3.3 Option 2 with solar option.....	58
5.4 Option 3 (mixing circuit with hygiene container)	59
5.4.1 Option 3.....	59

1 Design and function

1.1 Overview

ComfoBox combines all the necessary building technology in one compact form. In addition to heating, ventilation and hot water, ComfoBox can also cool the building. Optimally coordinated, high-quality components ensure efficient operation of all building equipment and smooth low-maintenance operation.

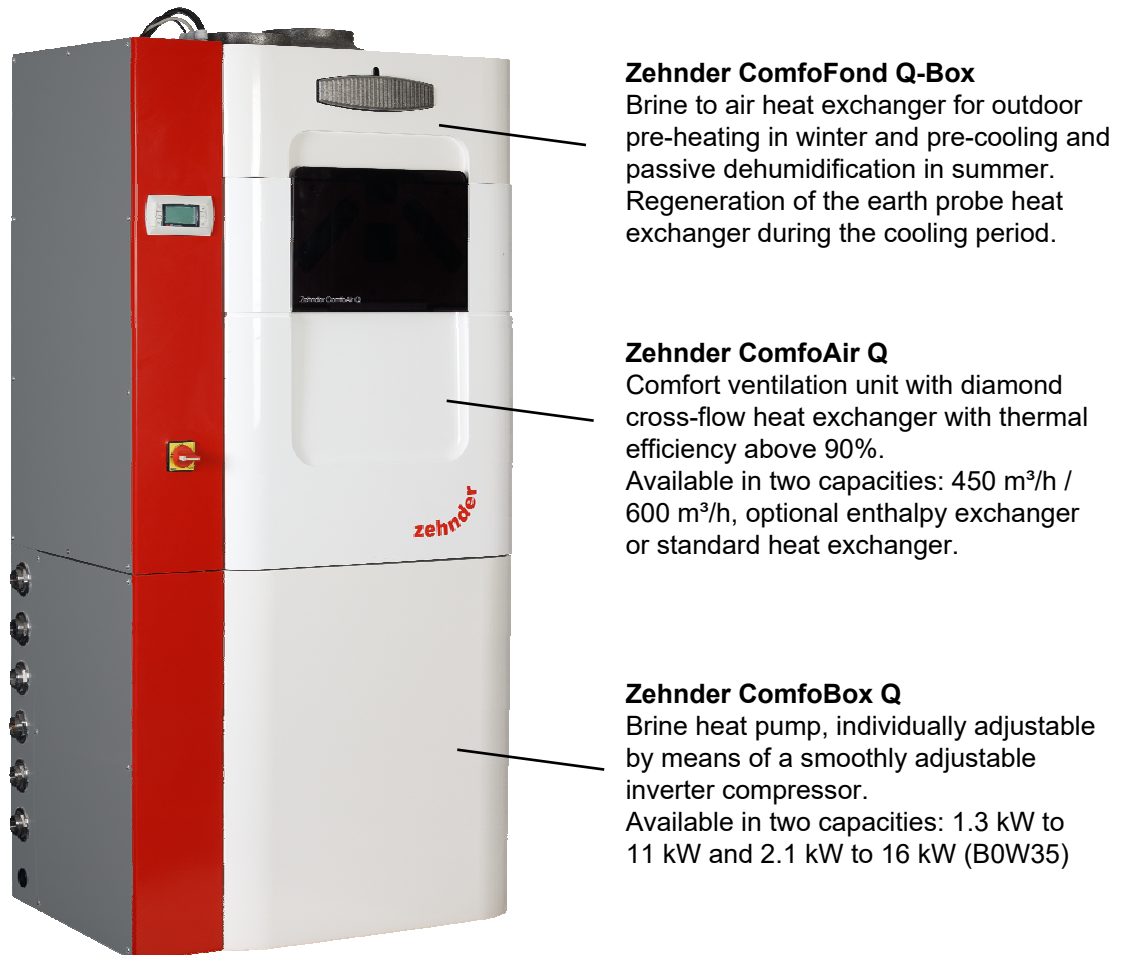

Fig 1. System overview

1.2 Functional diagram

The following diagram shows the most important elements of ComfoBox Q.

ComfoBox with 3 x 400 V power supply is equipped with cooling units with an electronically controlled expansion valve. The system is controlled by means of a so-called overheating controller.

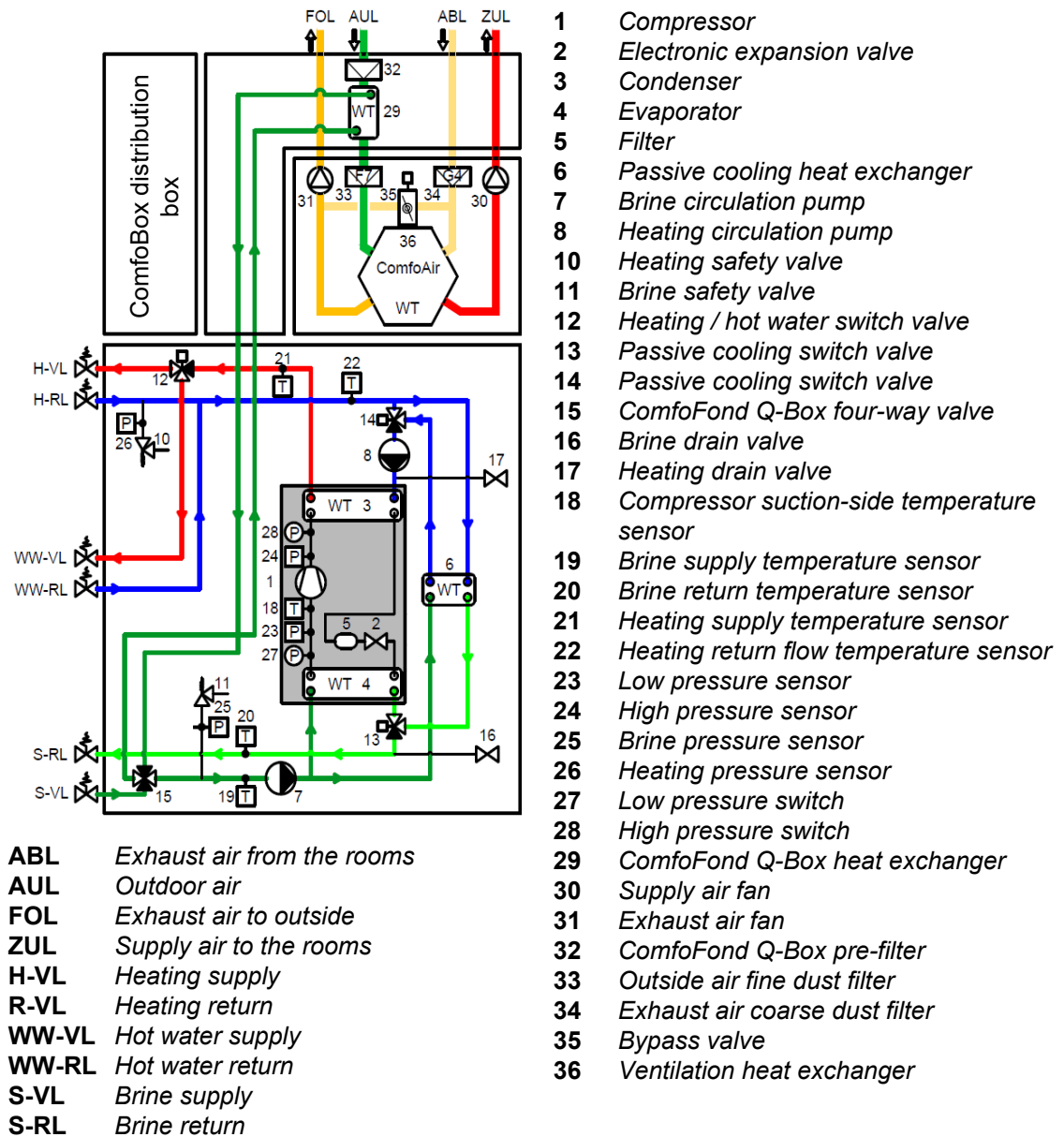

Fig 2. Function diagram of ComfoBox Q

1.3 Dimensions

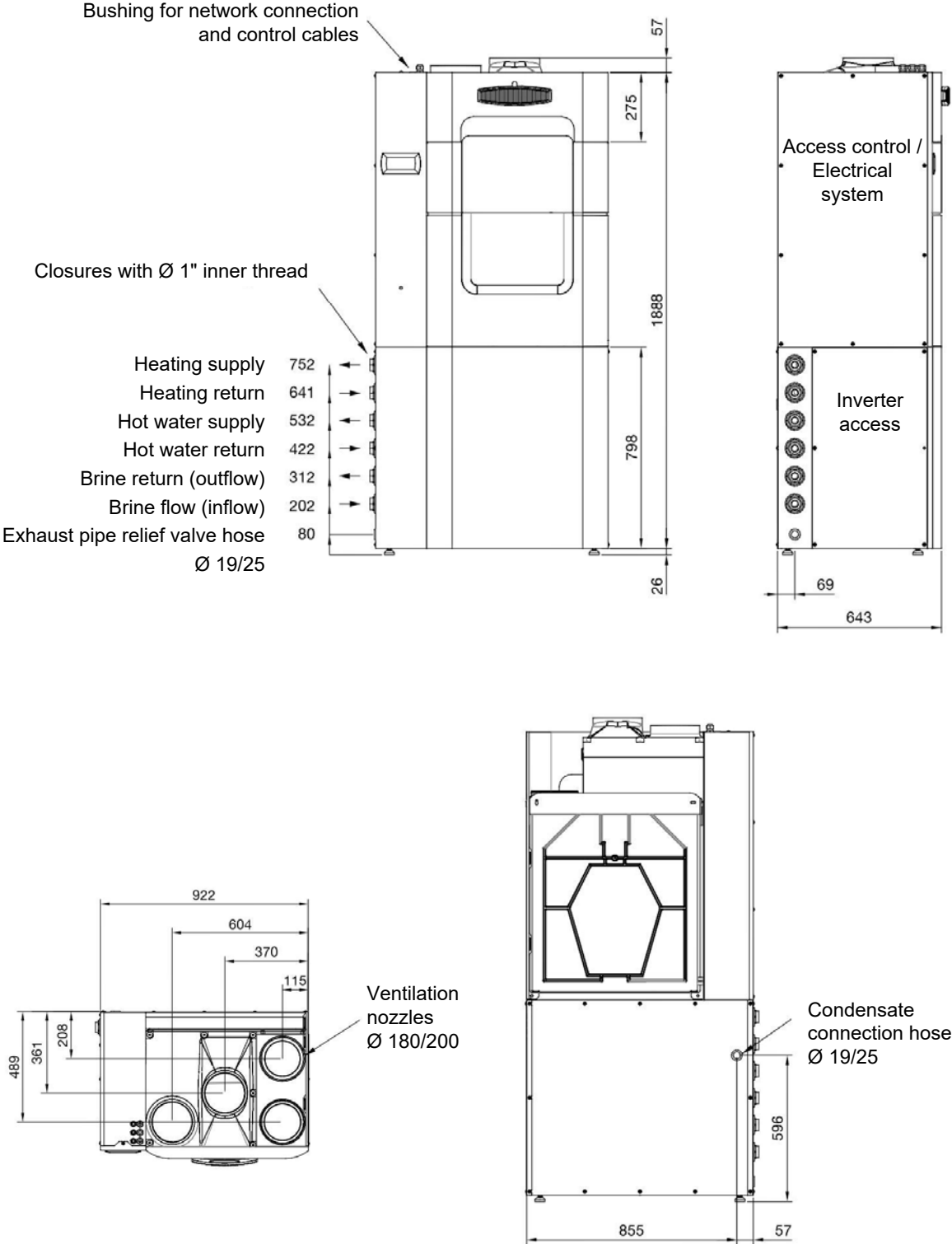

Fig. 3. ComfoBox dimensions (in millimetres)

1.4 Maintenance distances



Maintenance distance of ComfoBox must be 700 mm in front and left

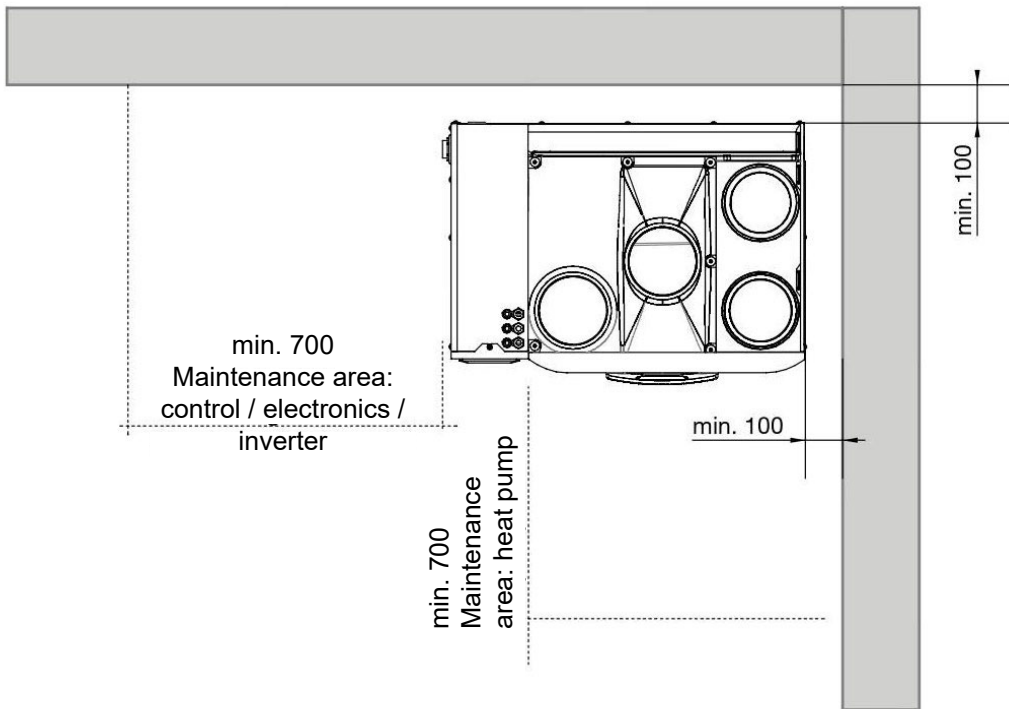

Fig 4. Maintenance distances: ComfoBox (in mm)

1.5 Heating



The design of the heating source and the heating load calculation must comply with applicable standards, norms and regulations.

ComfoBox is based on a brine-to-water heat pump that extracts heat from the environment via an earth probe, ground collector, spring or groundwater or wastewater source. The temperature of the earth is not subject to seasonal fluctuations such as outdoor air. Therefore, brine-to-water heat pumps, especially during the heating period, work much more efficiently than air-to-water heat pumps, which draw heat from the environment through the outdoor air. Brine-to-water heat pump systems do not make noise outside and do not require space outside the building. ComfoBox is available with heating capacities from 1.3 kW to 11 kW and 2.1 kW to 16 kW (BOW35). Heat is distributed in the building through surface heating, such as underfloor heating, wall heating or thermoactive ceiling heating, or through low-temperature radiators.

1.6 Cooling

ComfoBox has a passive cooling function (FreeCooling) that removes heat from dwellings and directs it back to the ground. Cooling is carried out very conveniently through the heating distribution system. The cooling function requires little power - only for the operation of the soil probe and heat distribution circulating pumps in the building. As a characteristic of Zehnder products, the highest ease of use is combined with optimal resource use.

Through the changeover valve, brine is passed through a passive cooling heat exchanger to achieve direct heat exchange between the brine and heating circuit (heat dissipation to the ground without heat pump operation). The brine flow through the heat exchanger shall be controlled by monitoring the flow temperature so that the flow temperature is $>19\text{ }^{\circ}\text{C}$ to prevent condensation.

In FreeCooling variant, the surface heating is cooled by an additional brine-to-water heat exchanger. If individual room temperature control is used for individual rooms, make sure that it can regulate both heating and cooling. In the cooling mode, the ComfoBox control system provides a 230V continuous signal that can be used to switch actuators individually to cooling mode using the ComfoTherm cooling bus or to close them in rooms that are not cooled.

1.7 Ventilation

ComfoBox is integrated with a comfort ventilation unit of type ComfoAir Q 450 with a maximum air flow of 450 m³/h or Comfoair Q 600 with a maximum air flow of 600 m³/h. It has a cross-current heat exchanger, energy-efficient EC motors and an automatically switching bypass. Through the heat exchanger, the heat from the extracted air is transferred to the supply air of the rooms with an efficiency of approximately 90%, in order to keep the energy loss as low as possible. The intake and exhaust fans are individually adjustable so that the ventilation of the building can be perfectly adjusted. Large surface filters are integrated into the comfort ventilation unit. Bypassing of the comfort ventilation unit allows bypassing of the heat exchanger in special temperature conditions.

The optional ComfoAir Q E type is equipped with a plate heat exchanger with humidity recovery (enthalpy exchanger) instead of a conventional heat exchanger. Retrofitting is possible at any time.

The ComfoFond Q-Box brine-air heat exchanger, which is placed in front of the comfort ventilation unit, can be preheated in winter to prevent the formation of ice in the heat exchanger. In the summer, it allows air to be pre-cooled before entering the comfort ventilation unit, which contributes to the cooling of the building.

In this case, the brine partial flow is passed through the ComfoFond Q-Box heat exchanger to achieve a direct heat exchange between the brine and the ambient air. Brine flow results from the position of the 4-way mixing valve in the primary circuit.

1.8 ComfoFond Q-Box

ComfoFond Q-Box is a brine to air heat exchanger that is placed inside the ComfoAir ComfoBox. Brine flows through the heat exchanger. It cools or heats the outside air before it enters the comfort ventilation unit. The ComfoFond option increases the output power of the brine circuit, which must be taken into account when designing the heat source.

1.9 Water heating

ComfoBox contains a 300 to 800 litre register boiler which is heated by a heat pump with a minimum energy consumption of up to 53 °C. The integrated 2-6 kW electric heater prevents legionellosis by heating the water regularly up to 60 °C and acts as a heater for hot water in the event of an accident. A larger boiler, solar boiler or combi boiler can be selected as an option.

When the changeover valve is on the flow, the heating circuit is fed into the water heater. Although all water heaters have a connection for circulation, the use of circulation is not recommended due to increased electricity consumption as with any heat pump system.

1.10 Options

1.10.1 Swimming pool heating

The swimming pool heating system can be connected using commercially available connection components, see the integration option schemes for swimming pool heating (**see chapters 5.2.2 and 5.3.2**).

When the pool pump is switched on, the ComfoBox receives a control signal to enable the swimming pool to be heated. The heating flow from the heat pump then flows through the pool heating circuit heat exchanger. To do this, you need to follow the ComfoBox priorities:

1. Warm water, 2. Heating, 3. Swimming pool heating.

1.10.2 Energy source: spring water, groundwater

Instead of a soil probe or soil register, spring water or groundwater may be used as heat source using commercially available connection components.

The brine circuit is heated by a heat exchanger. For example, the heat exchanger is fed by spring water, which is pumped by a pump and flows out to the infiltration system.

1.10.3 Solar water heating

Solar water heaters 600, 800 and 1000 litres with an additional register for solar energy (**see chapters 5.2.3 and 5.3.3**).

1.10.4 Buffer tank

Buffer tanks 200, 300, 500 or liters.

For use with heat generation systems of different temperatures or low temperature and low storage heating systems (underfloor dry construction system, ceiling heating, etc.)

The heating circuit can be connected to the buffer tank via a serial connection or in parallel. The buffer tanks are insulated against freezing and do not require bypassing of the buffer during cooling.

1.10.5 Hygiene container

Combined 960 litre buffer tank with integrated corrugated pipe spiral exchanger for DHW production. The only way to use a solar energy system for heating is to use a hygiene container with an integrated solar thermal coil.

To use passive cooling, it is mandatory to ensure that the hygiene container is bypassed.

1.11 Installation / interfaces

Modbus interface for integration with the building automation system. All data points can be read and the activation of different heating and cooling requirements can be described (**see chapter 3.3.15**).

1.12 Offer text

Heating, cooling, water heating and comfort ventilation with brine/air heat exchanger connected to one compact energy centre.

Brine-to-water heat pump individually controlled by a stepless inverter compressor, compact-controlled circulators installed in a compact design for brine and heating circuits, safety valves, switching valves and shut-off devices ready for connection. All temperature and pressure sensors required for smooth operation are integrated into the device. Outdoor temperature and water heater sensor are included in the delivery.

Integrated electric emergency heating, which is activated by the customer in the event of a malfunction and heats the heating water.

Cooling unit with electronically controlled expansion valve. The control unit and all necessary electronics are ready for connection. With a regulator to control the heat pump and the heating of the rooms. Modbus interface for integration with building automation.

Available in two different heating capacities (1–9 kW and 3–12 kW).

Heat output B0W35: 1.3 kW to 11 kW (Q-Box 1-9 kW), 2.1 kW to 16 kW (Q-Box 3-12 kW)

COP B0W35: 4.5 (Q-Box 1-9 kW) and 4.6 (Q-Box 3-12 kW)

Heat source limit of use: -25 °C to +35 °C

Heating limit of use: +10 °C to +60 °C

Nominal compressor voltage: 400 V

Control unit rated voltage 230 V

Emergency heating rated voltage: 400 V

Starting current: 0.9 A to 1.9 A (Q-Box 1-9 kW), 0.7 A to 2.6 A (Q-Box 3-12 kW)

Freezing agent: R 410a

Height: 1980 mm / width: 920 mm / depth: 640 mm

Connection on the heating and brine side: 1" IG

2 Installation

- A clean and well-lit room must be prepared for ComfoBox. The room must be accessible through the door (minimum distance 780 mm) so that ComfoBox can be inserted and individual components, such as the boiler, can be removed later.
- ComfoBox must be installed in a non-freezing room. It is recommended to install ComfoBox in a heated room (e.g. in a fully insulated basement or utility room) so that the residual heat supports the heating of the room. Condensate water must be discharged without risk of freezing, with the specified slope and using a siphon.
- The installation site must be chosen so that there is enough space around ComfoBox for connections and enough space in front of ComfoBox for maintenance work. Before installing ComfoBox, all pipes must be led into the room. Floor drains must be functional. The room must have the following connections:
 - Air connections out of the building and to the building's distribution system
 - Ground probe connection
 - Heating connection
 - Clean water / hot water connection
 - 3 x 400V power connectors
 - Condensate drain or device for removal of condensate
- ComfoBox is positioned manually or with a suitable lifting device in a precise position, if possible on a prepared base. The system is set to horizontal using levelling screws.
- ComfoBox must be installed in accordance with general and local safety and installation regulations, including those of utility companies, and with the requirements set out in this document.
- Structural sound transmission to the building and piping must be avoided.
- External walls and roof penetrations must be provided with vapour tight insulation to prevent condensation on the wall or roof.
- It is recommended to install the air connections in both the intake and exhaust air using the air valves.



Only qualified personnel of Zehnder Group Schweiz AG may perform commissioning works.

2.1 Assembling ComfoBox Q



The device must be assembled by two persons. During assembly/disassembly, one person must hold the parts of the enclosure to prevent them from falling and the other person must fasten them.

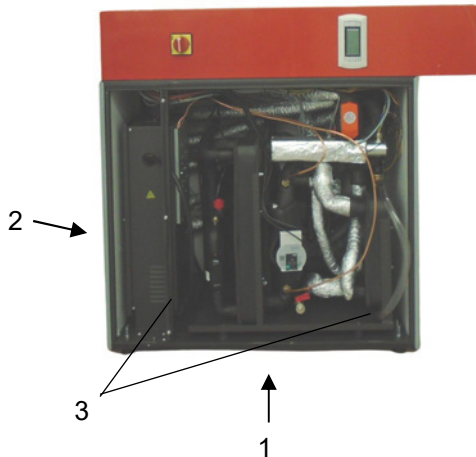

Positioning of the heat pump/hydraulic unit

1. Disassemble the front panel (pos.1) and the left side panel (pos. 2)
2. Release the transport locks (pos. 3), lift ComfoBox from the pallet and place it in the prepared position, if possible on the prepared pallet, and level it using the foot screws.

Do not push the unit as it may bend the legs!

Use the foot screws to set the heat pump/hydraulic unit horizontal



Observe compliance with required minimum distances.

Installation of the power module

Install the electrical module and secure it with the screw (pos.1)

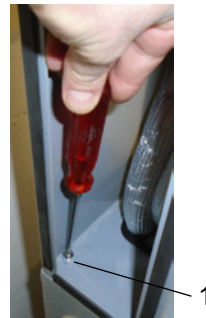

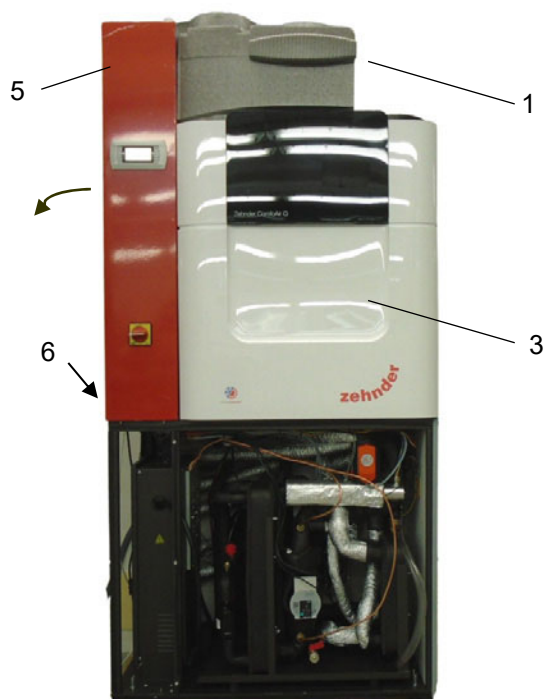

Installation of the ventilation unit and ComfoFond

Insert the condensate nozzles (pos. 1) and the cap (pos. 2) under the ventilation unit and place the ventilation unit (pos. 3) on the heat pump module.



The device can only be used as a right-hand device. Conversion to the left version is not possible.

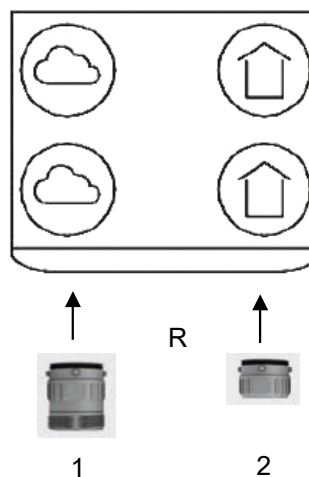

Place the ComfoFond Q-Box (pos. 4) on the ventilation unit.

To do this, tilt the electrical module (pos. 5) under an angle.

The module mounting screw must be unscrewed again (pos.6)

Comfoair cable

3. Comfoair ventilation unit power supply (pos. 1) cable is routed either to the 230V socket or along the back wall of the ventilation unit to the electrical module (pos. 3)

4. ComfoNet connection cable (pos. 2) can be controlled from the electrical module to the connection terminals of ComfoAir, if necessary.

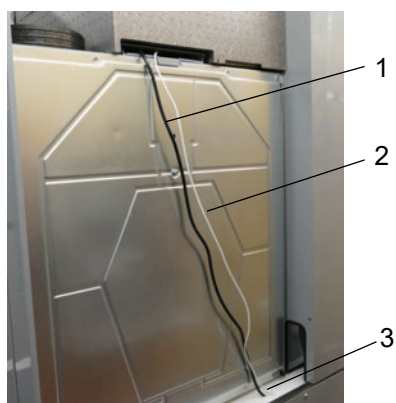

The electrical module has terminals for the power supply and the ComfoNet connection cable. (see chapter 3.3.19)

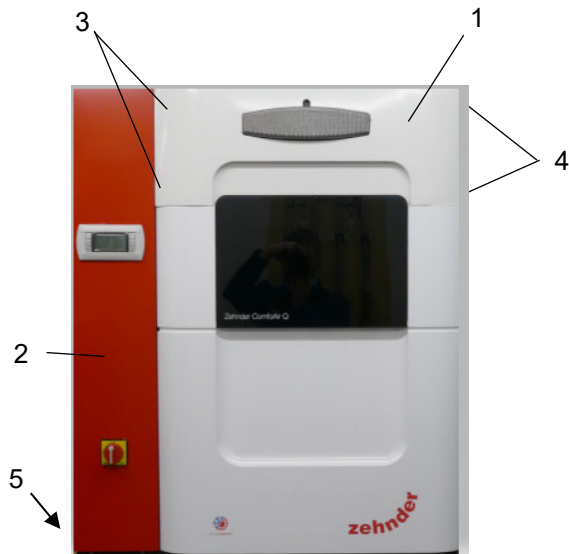

Installation of panels

5. Install the ComfoFont front panel (pos. 1). To do this, tilt the electrical module (pos. 2) slightly and insert the front panel tabs into the openings of the electrical module (pos.3). Install the side panel to the right and screw it to the front panel with two screws (pos. 4). Attach the electrical module (pos. 2) with four screws (pos. 5).

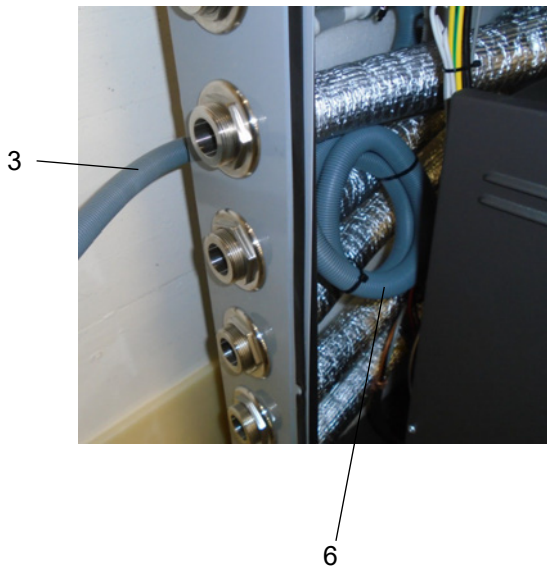

Installation of the condensate drain

6. Screw the hose connection (pos. 1) to the connection at the bottom of the ComfoAir (pos. 2). Tighten the nut by hand (do not forget the seal!).

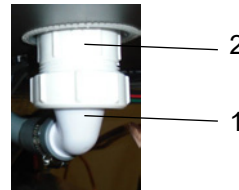

7. Push the condensate drain hose (pos.3) from the inside through the wall of the housing.
8. The condensate drain hose can be driven out of the housing either from the rear (pos. 4) or all of them (pos. 5) (**see chapter 3.1**).

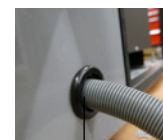
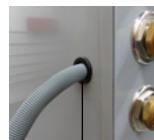

The condensate drain hose of the siphon is included! (Pos. 6).

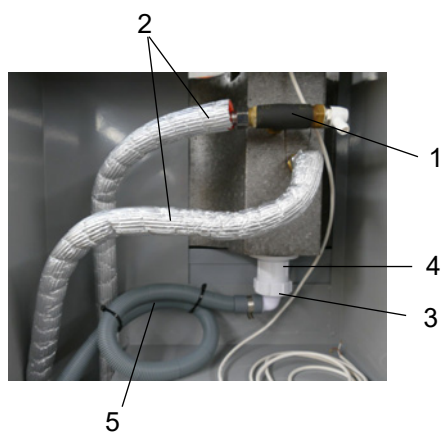

Connecting ComfoFond

9. Install the insert (pos. 1)
Connect the two tubing connections (pos. 2) to the ComfoFond register. Tighten them with a suitable tool. (Don't forget the seal!)
10. Screw the hose connection (pos. 3) to the connection at the bottom of ComfoFond (pos. 4). Tighten the union nut manually. (Don't forget the seal!)



Siphon condensate drain hose included! (pos. 5)

Installation of panels

Install the front panel of the heat pump module (pos. 1) and secure it with 6 screws. Install the red front panel (pos. 2) and connect it to the upper red front panel (pos.3). The two red front panels are secured from above with a screw (pos.4). Install the left side panel (pos. 5) and the power module cover (pos. 6) and secure it with the screws.

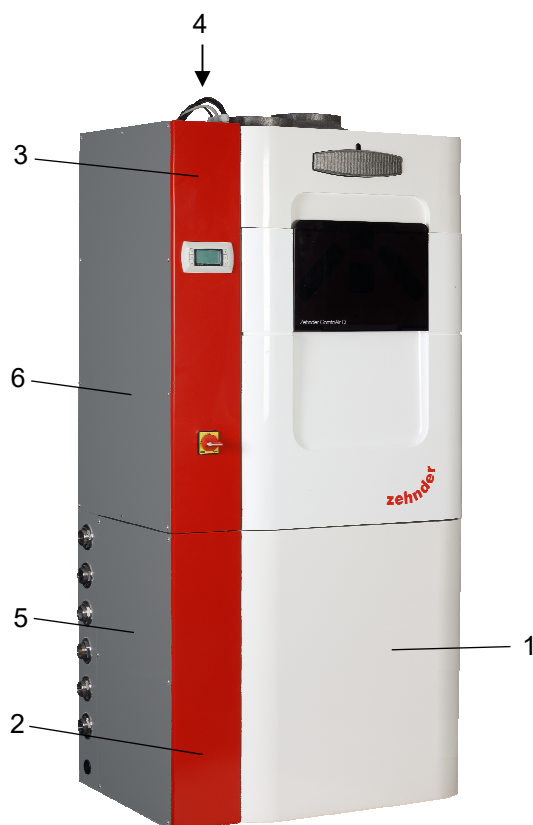

3 Connections

3.1 Overview

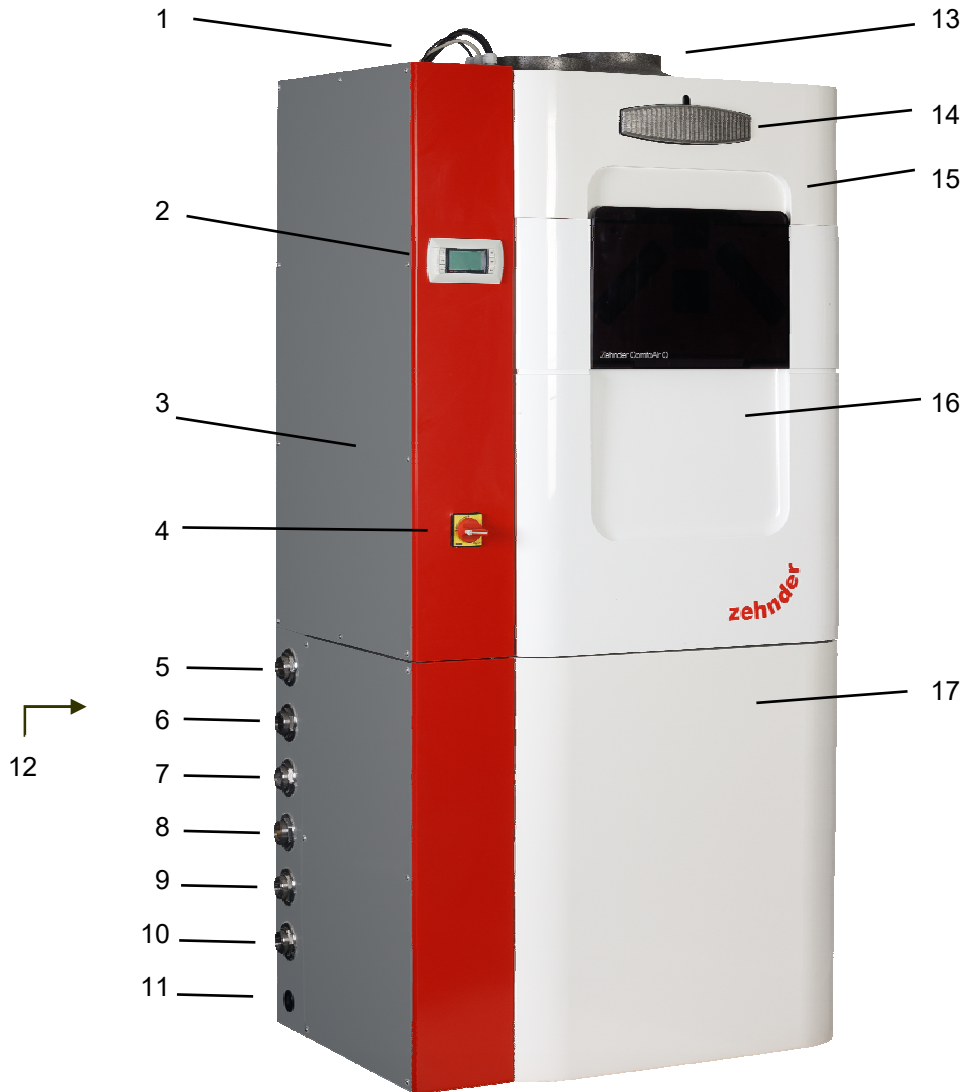

Fig. 5. ComfoBox connections

- | | | | |
|---|---------------------|----|---|
| 1 | Electrical entries | 9 | Brine supply (inflow) |
| 2 | Control unit | 10 | Brine return (outflow) |
| 3 | Electrical module | 11 | Condensate drain (optional at the bottom) |
| 4 | Master power switch | 12 | Condensate drain (in the rear) |
| 5 | Heating supply | 13 | ComfoAir Q connections |
| 6 | Heating return | 14 | ComfoFond Q-Box filter |
| 7 | Hot water supply | 15 | ComfoFond Q-Box air preheating |
| 8 | Hot water return | 16 | ComfoAir Q comfort ventilation unit |
| | | 17 | Heat pump / hydraulic unit |

3.2 Connections

The following connections shall be established:

Media	Connection to ComfoBox	Comments
Heating for heat dissipation (2x)	1" inner thread	Ball valve included in delivery
Heating pipes to water heater (2x)	1" inner thread	Ball valve included in delivery
Surface probes (2x)	1" inner thread	Ball valve included in delivery
Ambient air	Nozzles Øi 180 / Øa 200 mm	Direct connection to Zehnder ComfoPipe 200
Exhaust air	Nozzles Øi 180 / Øa 200 mm	
ComfoAir and ComfoFond condensate	PVC hose, Øi 19 / Øa 25 mm	Connection on the rear side or also the resupply connection on the bottom left



It is recommended to install an automatic deaeration fan in each heating, hot water and brine circuit.

3.2.1 Thermal insulation of connecting pipes

Pipe	Type of insulation
for ground probe to water heater	including fittings with permanent and vapour-tight insulation
Heat distribution	Insulation
	Insulated only unheated rooms

3.2.2 Circulation pumps

The following OEM pumps are used as standard:

ComfoBox	1-9	3-12
Brine circuit	Wilo Stratos Para 25/1-8	Wilo Stratos Para 25/1-11
Heat circuit	Wilo-Para STG 15-130 7-50	Wilo-Para STG 25-180 8-75

The brine pump flow rate shall be controlled by means of the temperature difference ΔT 3K, the heat circuit pump flow rate in general by means of the pressure difference ΔP . In heating systems with a constant pressure drop, the flow regulation of the circulation pumps can also be adjusted by the temperature difference ΔT 5K. The Δt adjustment is controlled by the 0-10 V signal from the WP controller.

3.2.3 Pump diagram ComfoBox 1-9

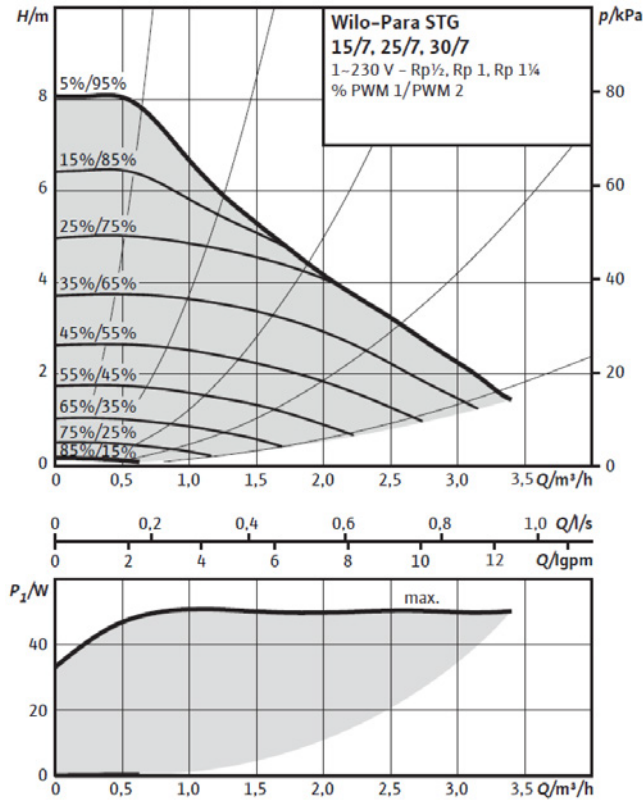

Fig. 6. Heat circuit, Wilo-Para STG 15-130 7-50

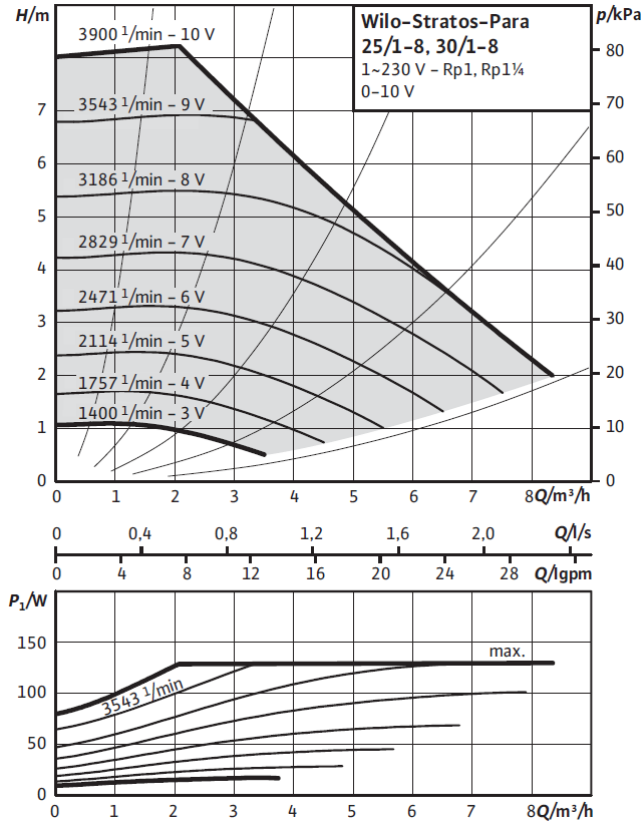

Fig. 7. Brine circuit, Wilo Stratos Para 25/1-8

3.2.4 Pump diagram ComfoBox Q 3-12

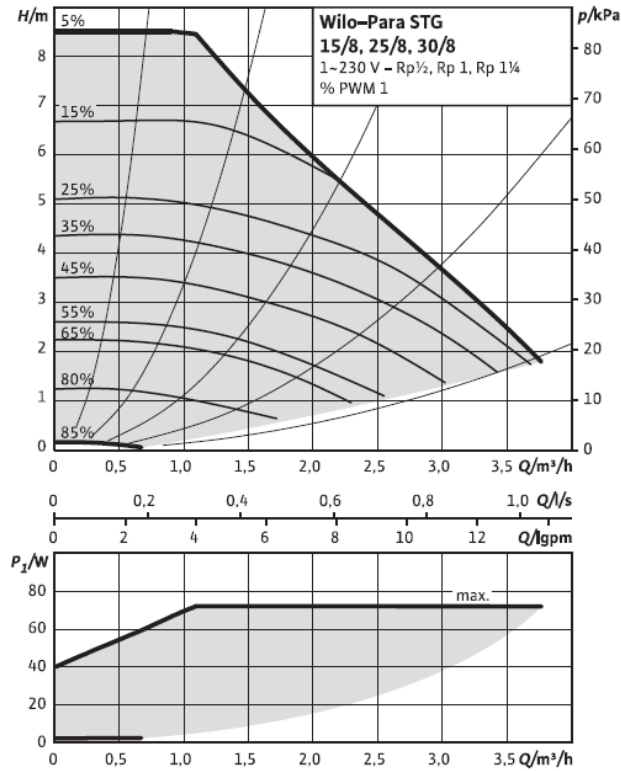

Fig. 8. Heat circuit, Wilo-Para STG 25-180 8-75

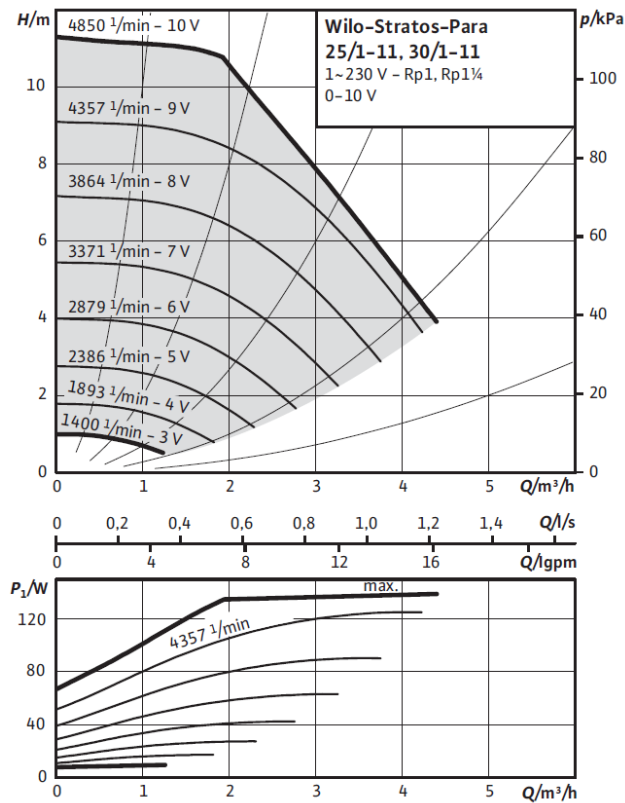

Fig. 9. Brine circuit, Wilo Stratos Para 25/1-11

3.3 Electrical connections

3.3.1 Wiring concept

Through the electrical circuit of the heat pump, the system is controlled by various devices that are located inside the heat pump or that must be installed externally. The internal components are wired together in the factory. Depending on installation, it may be necessary to connect different temperature sensors (analog inputs A_{ixx}), control signals or other external devices (digital inputs D_{lxx}), switch on/off pumps and valves (digital outputs D_{Oxx}) or adjust pumps and/or valves (analog outputs A_{Oxx}) in addition to the power supply.

- ComfoBox is externally protected (see chapter 3.3.2).
- All internal electrical contacts (e.g. compressor, pumps, switching valves, etc.) lead to the electrical module connector. The internal wiring is installed ready for connection.
- All external contacts (e.g. mains connection, control unit, weather sensor, emergency heating electric heater, etc.) lead to the plug connections of the electrical module.
- A possible EW lock may be connected.

Location of components in the electrical module

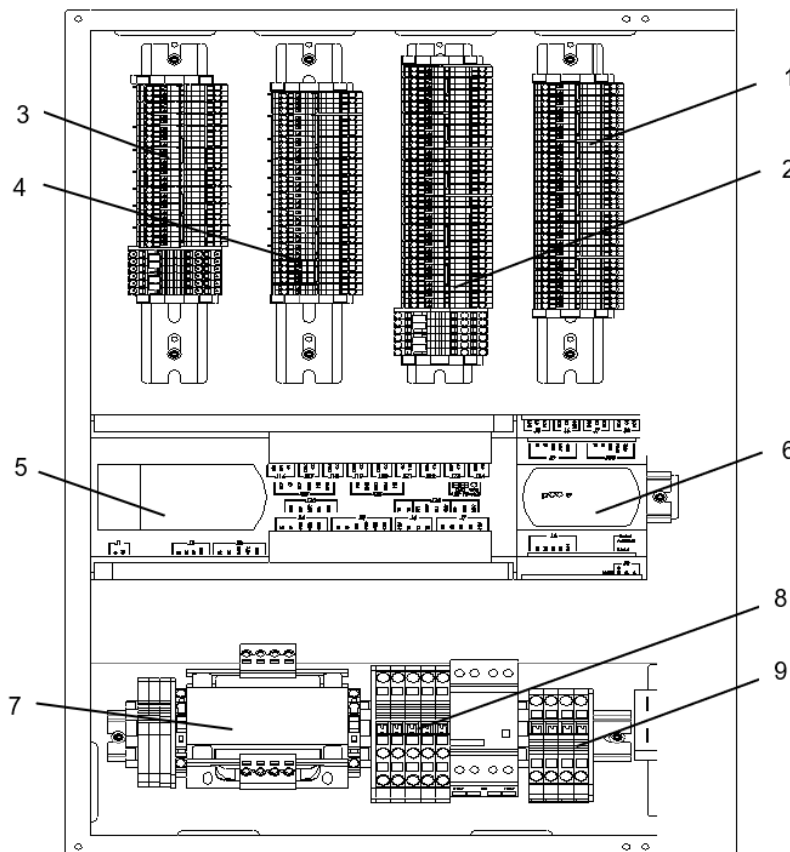

- 1 Block I (AI analog inputs)
- 2 Block II (DI digital inputs) (AO analog outputs)
- 3 Block III (DO digital outputs)
- 4 Block VI (DO digital outputs)
- 5 Controller pCO OEM+
- 6 Expansion module controller
- 7 Transformer 24 V AC
- 8 Heat pump power supply
- 9 Power supply for emergency heating electric heater

Fig. 10. Electrical module terminals

3.3.2 Electrical connections



Electrical installation must be carried out in accordance with local regulations.

This wiring diagram shows the on-site installations in the electrical cabinet.

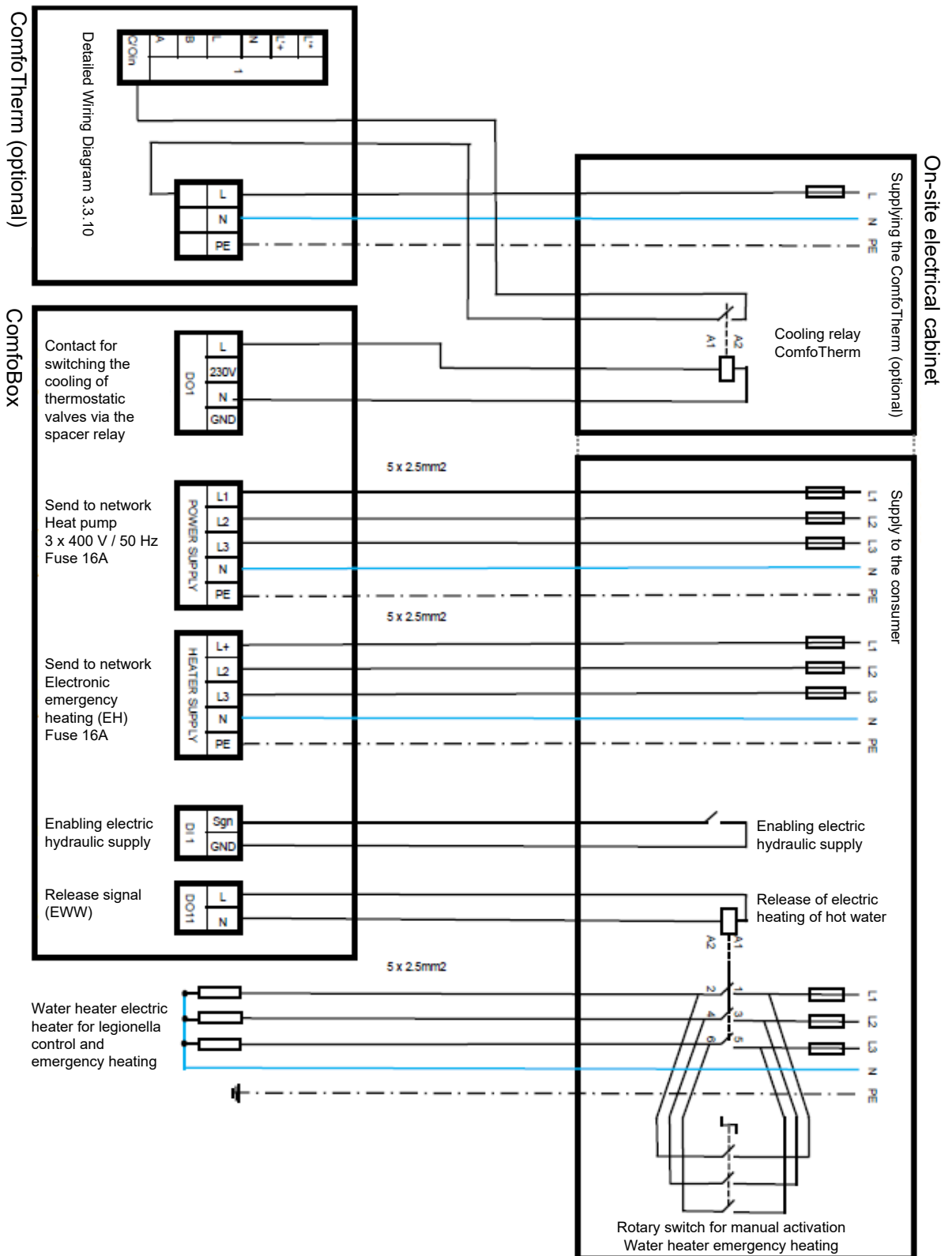

Fig. 11. Electrical cabinet circuit diagram - ComfoBox

3.3.3 Electrical module terminal blocks

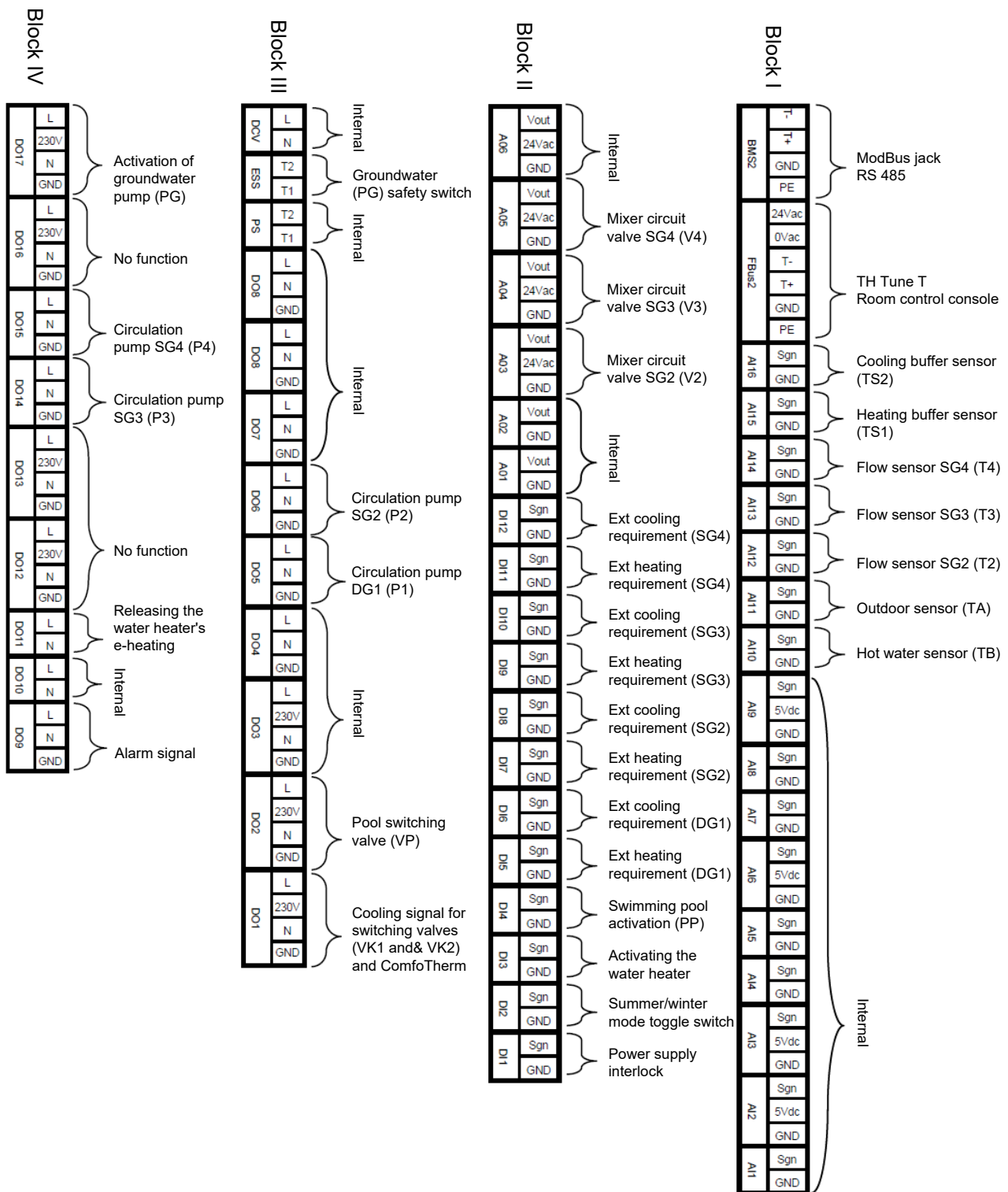

Fig. 12. Electrical module terminal block

3.3.4 Wiring diagram option 1

The TH-Tune room control console is intended for use only in systems where there is no individual adjustment of the rooms. To adjust the entire building, the location of the reference sensor must be carefully selected.

In general, it is preferable to use individual room adjustment, that is, without a room control box.

TH-Tune (optional)
Room control console

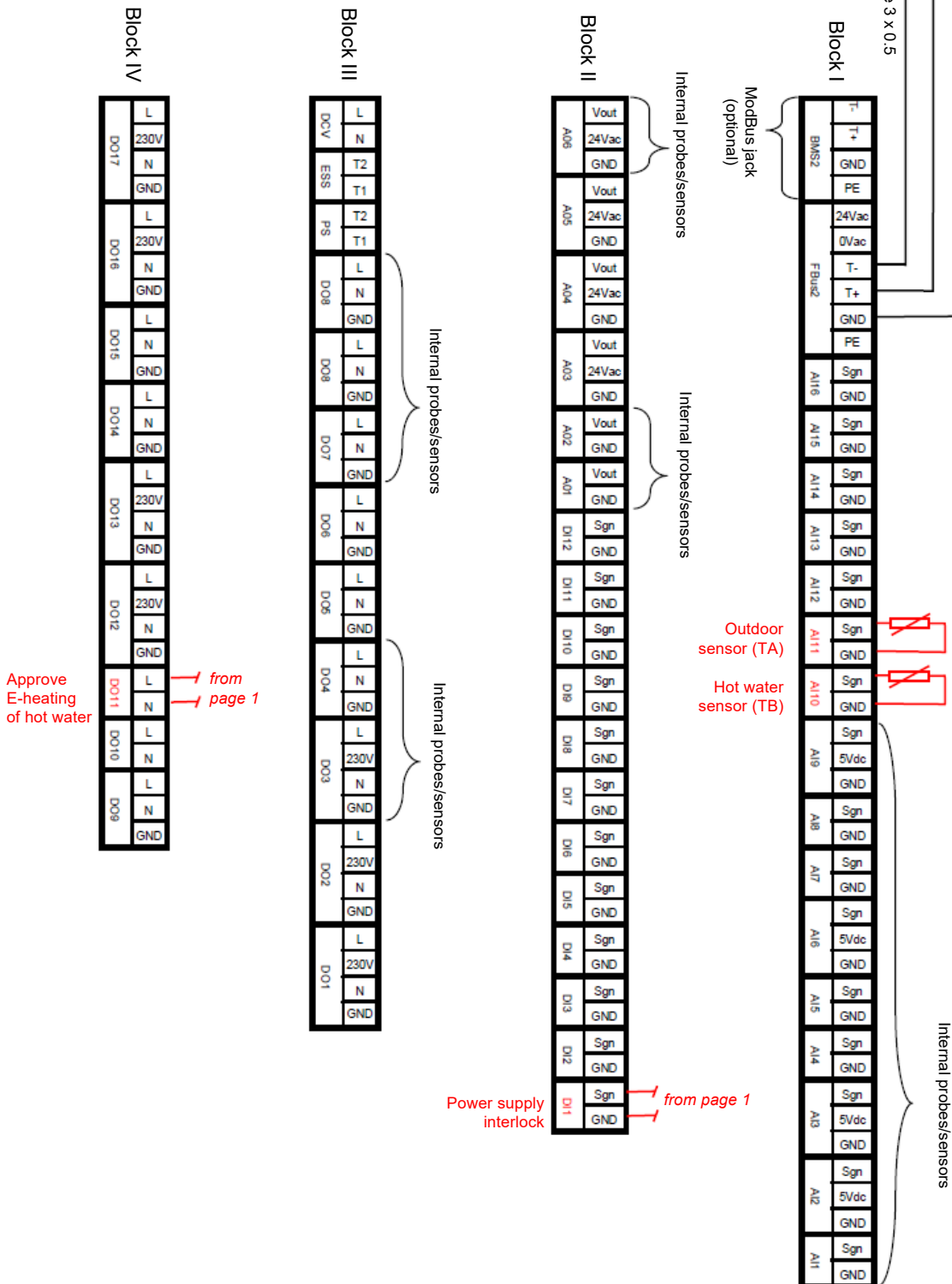
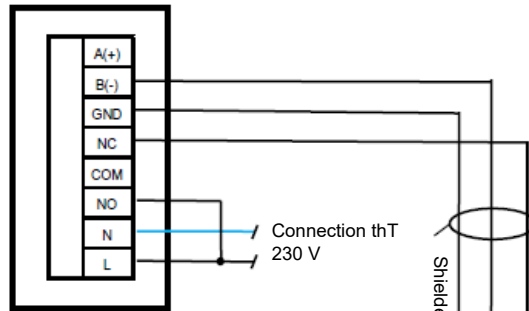

Fig. 13. Electrical module terminal block option 1

3.3.5 Wiring diagram option 2

The TH-Tune room control console is intended for use only in systems where there is no individual adjustment of the rooms. To adjust the entire building, the location of the reference sensor must be carefully selected.

In general, it is preferable to use individual room adjustment, that is, without a room control box.

TH-Tune (optional)
Room control console

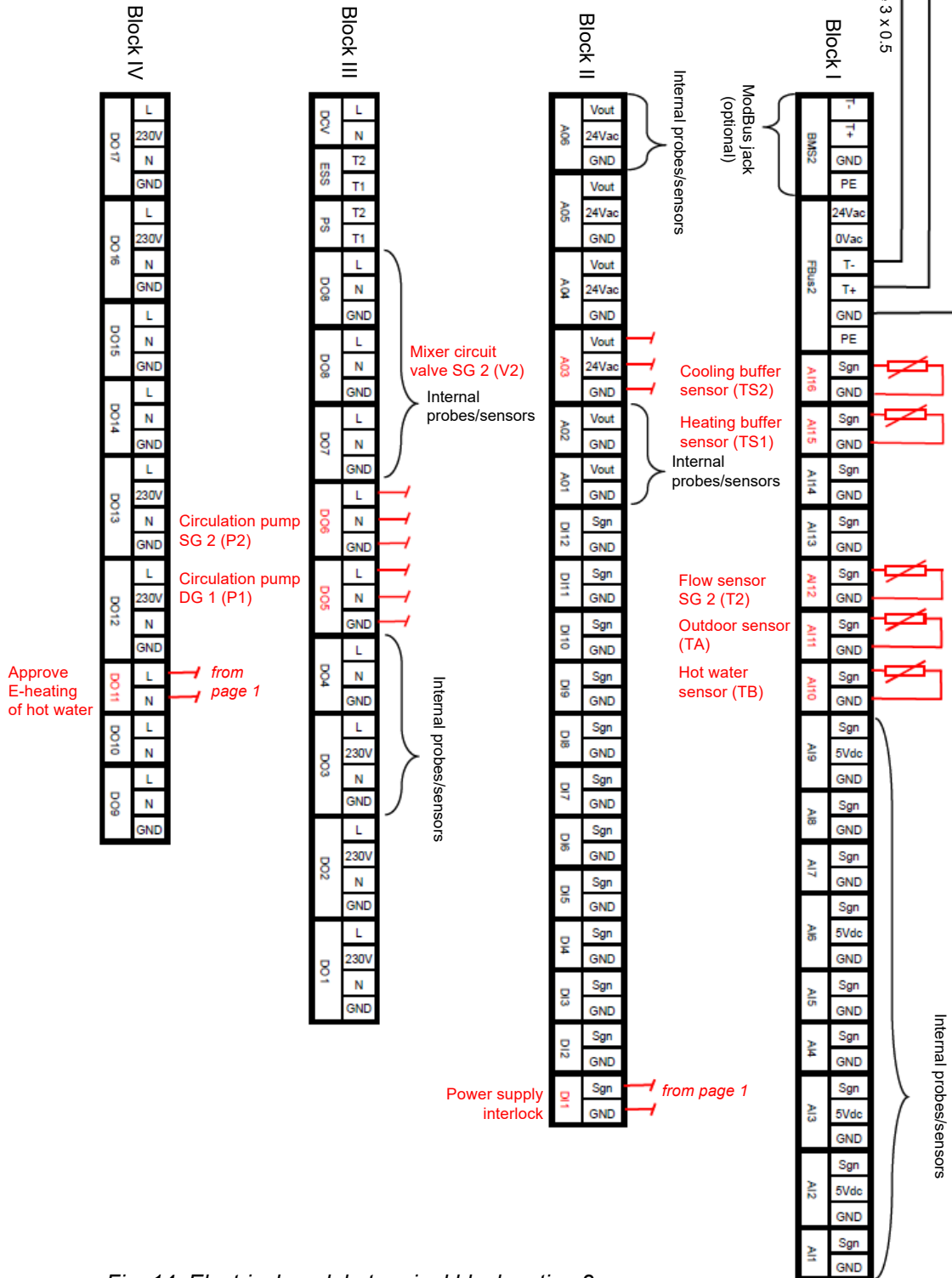
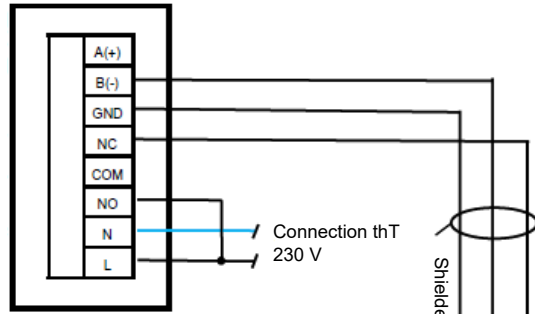

Fig. 14. Electrical module terminal block option 2

3.3.6 Wiring diagram option 3

The TH-Tune room control console is intended for use only in systems where there is no individual adjustment of the rooms. To adjust the entire building, the location of the reference sensor must be carefully selected.

In general, it is preferable to use individual room adjustment, that is, without a room control box.

TH-Tune (optional)
Room control console

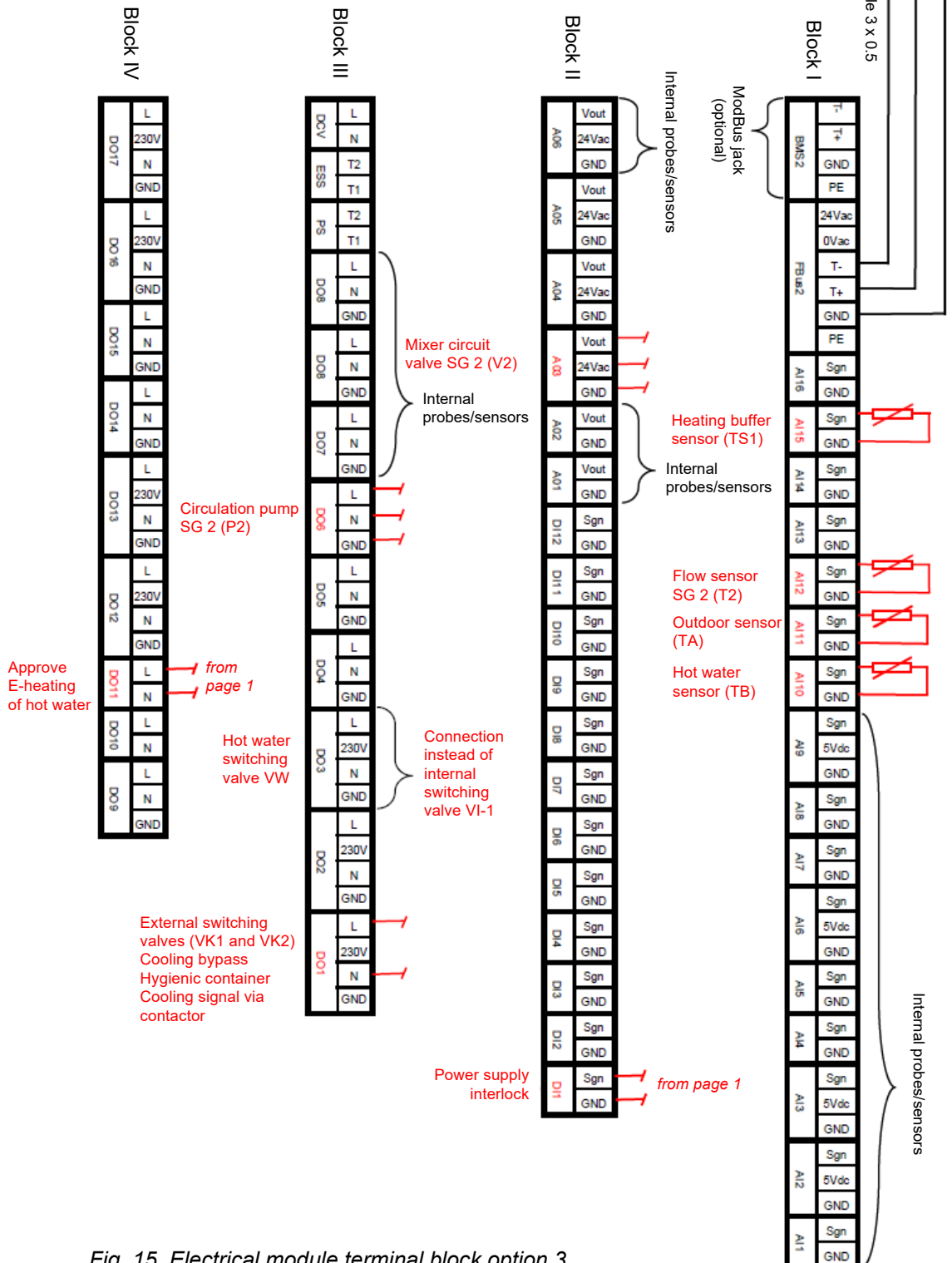
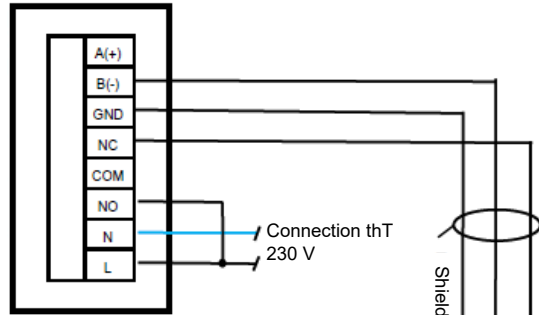

Fig. 15. Electrical module terminal block option 3

3.3.7 Analog inputs (AI) → Block I

These connections are used to connect external temperature sensors. Only passive 10kOhm type NTC temperature sensors can be connected, so the polarity of the cables is not important.

Extension cables with a maximum length of 50 m and a minimum cross-section of 0.752 may be used if necessary.

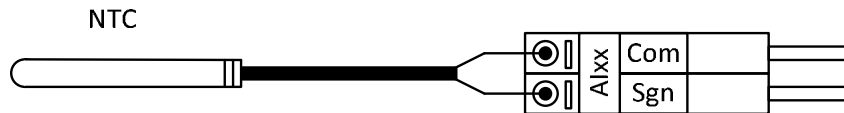

Fig. 16. Analogue input (AI)

Terminal	Type	Signal
Block I / AI10	NTC 10K 25°C	Temperature sensor water heater (TB)
Block I / AI11	NTC 10K 25°C	Outdoor temperature sensor (TA)
Block I / AI12	NTC 10K 25°C	Flow sensor SG2 (T2)
Block I / AI13	NTC 10K 25°C	Flow sensor SG3 (T3)
Block I / AI14	NTC 10K 25°C	Flow sensor SG4 (T4)
Block I / AI15	NTC 10K 25°C	Heating buffer sensor (TS1)
Block I / AI16	NTC 10K 25°C	Cooling buffer sensor (TS2)

3.3.8 Digital inputs (DI) → Block II



Consider the operating voltage of the individual digital inputs. Failure to do so may result in malfunction of the heat pump or damage to its components. There are digital inputs that require potential-free signals; the rest require 24 VAC signals.

Potential-free signals must not be mixed with 24V AC signals.



Peripherals may be connected directly to the heat pump at 24 V AC; the total number of connected units shall not exceed 36 VA or 1.5 A. Failure to comply with these limits may result in malfunction of the heat pump and/or damage to the components.

Digital signals from thermostats or other peripherals can be connected to these connections to control the heat pump's production functions.

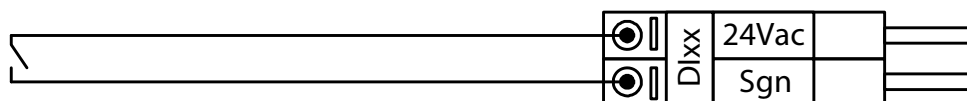

Fig. 17. Digital input (DI)

Terminal	Type	Signal
Block II/ DI1	Potential-free (0 V)	Power supply interlock
Block II/ DI2	Potential-free (0 V)	Summer/winter switch
Block II/ DI3	Potential-free (0 V)	Ext requirement for water heater
Block II/ DI4	Potential-free (0 V)	Ext pool requirement (PP)
Block II/ DI5	AC voltage 24 V	Ext heating requirement (DG1)
Block II/ DI6	AC voltage 24 V	Ext cooling requirement (DG1)
Block II/ DI7	AC voltage 24 V	Ext heating requirement (SG2)
Block II/ DI8	AC voltage 24 V	Ext cooling requirement (SG2)
Block II/ DI9	AC voltage 24 V	Ext heating requirement (SG3)
Block II/ DI10	AC voltage 24 V	Ext cooling requirement (SG3)
Block II/ DI11	AC voltage 24 V	Ext heating requirement (SG4)
Block II/ DI12	AC voltage 24 V	Ext cooling requirement (SG4)

3.3.9 Analog outputs (AO) → Block II

These connections provide analog signals for controlling 0-10 V DC mixing valves in mixing circuit heating circuits. In addition, these connections are powered by a 24V AC connection for the mixer valve motor.

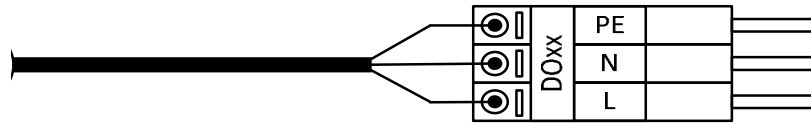

Fig. 18. Analog output (AO)

Terminal	Type	Signal
Block II/ AO3	0-10V DC	Mixer circuit valve SG2 (V2)
Block II/ AO4	0-10V DC	Mixer circuit valve SG3 (V3)
Block II/ AO5	0-10V DC	Mixer circuit valve SG4 (V4)

3.10 Digital outputs (DO) → Block III, Block VI

These connections provide 230V AC activation signals to various external components such as changeover valves or heating circuit pumps, etc.

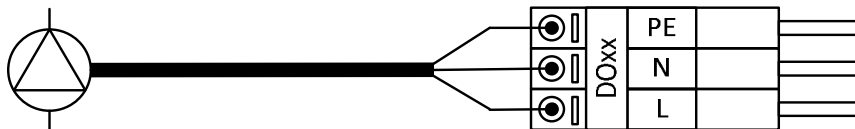

Fig. 19. Digital output (DO)

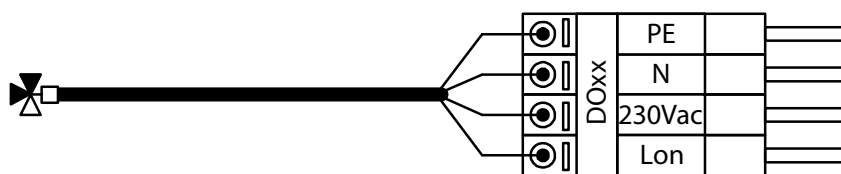

Fig. 20. Digital output (DO)

Terminal	Type	Signal
Block III/ DO1	Activation max. 230V AC / 1A	Comfotherm cooling signal and hygiene tank bypass storage (Option 3)
Block III/ DO2	Activation max. 230V AC / 2A	Pool switch valve (VP)
Block III/ DO5	Activation max. 230V AC / 2A	Circulation pump DG1 (P1)
Block III/ DO6	Activation max. 230V AC / 2A	Circulation pump SG2 (P2)
Block III/ DO9	Activation max. 230V AC / 2A	Alarm signal
Block IV/ DO11	Activation max. 230V AC / 2A	Release of the water heater's e-heating
Block IV/ DO14	Activation max. 230V AC / 2A	Circulation pump SG3 (P3)
Block IV/ DO15	Activation max. 230V AC / 2A	Circulation pump SG4 (P4)
Block IV/ DO17	Activation max. 230V AC / 2A	Activation of groundwater pump (PG)

3.3.11 Power supply to the heat pump

The heat pump is powered from the "POWER SUPPLY" terminal. This leads to the aggregate terminals via the main switch, from which all internal components are powered.

ComfoBox size (kW)	Max. current consumption (A)	Max. starting current (A)	Operating voltage (V)	Recommended external protective equipment (A)
3L / N / PE / 50 Hz / 400 V				
1-9	5.5	1.9	3 x 400	3 x 10
3-12	7.2	2.6	3 x 400	3 x 16

3.3.12 Power supply: internal emergency heating

The internal emergency heating consists of three heating resistors connected in a three-phase and star configuration. Thus, 6 kW electrical heat output is available (2 kW for each heating element). The heating device is activated manually through the control of the heat pump in the event of a malfunction of the heat pump. The safety thermostat of the heater is connected internally.



The electrical supply to the electric heater must be separately powered. This connection is not made via the main switch of the heat pump.

Heating capacity (kW)	Cable cross-section (mm ²)	Recommended external fuse (A)
3L / N / PE / 50 Hz / 400 V		
6	2.5	3 x 16

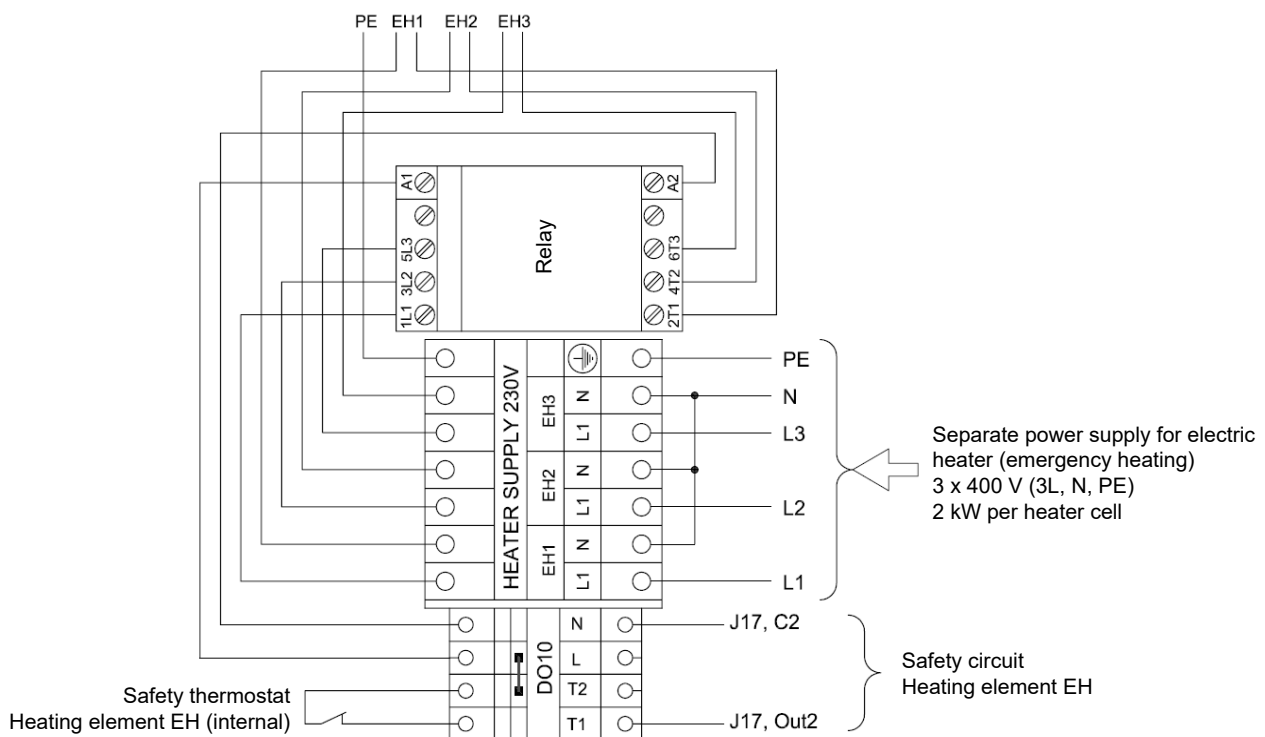

Fig. 21. Internal electric emergency heating connection diagram

3.3.13 ComfoTherm

The ComfoTherm control system allows the floor heating drives to be opened during passive cooling. In this case, the cooling signal of the heat pump is used.

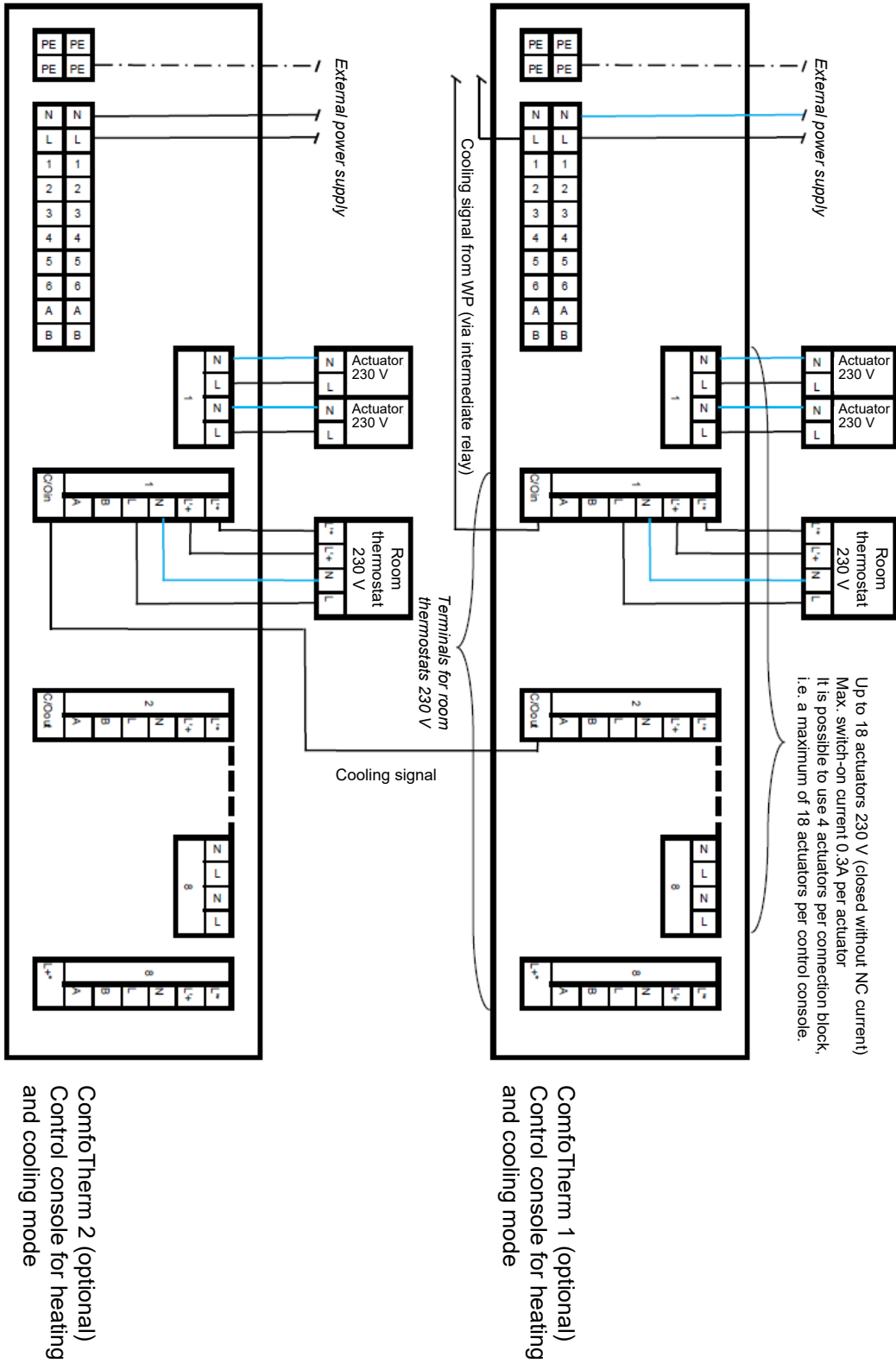

Fig. 22. ComfoTherm connection diagram

3.3.14 Heat pump room control console

If desired, the heat pump can be controlled using the room control console. Electricity is supplied externally. Communication with ComfoBox is via a shielded cable 3 x 0.5 mm².



The room control console makes the control of the heat pump from weather-compensated control to room-compensated flow temperature control. Therefore, the location of the room control console must be carefully selected.



In systems for adjusting individual rooms, an additional room control box is absolutely not necessary.

Terminal	Signal	Description
FBus2	ModBus RS485	TH-Tune communication

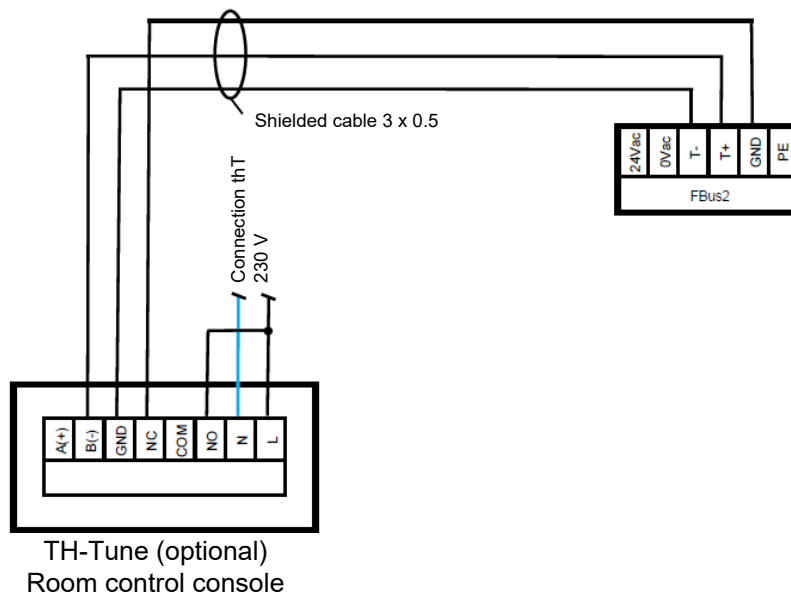

Fig. 23. TH-Tune connection diagram

3.3.15 ModBus

ComfoBox allows communication via ModBus. It is possible to send on/off signals, signals about hot water or pool demand. Heating and cooling requirements for individual heating groups are also available. (See Chapter 3.3.5)

Terminal	Signal	Description
BMS2	ModBus RS485	ModBus Read/Write

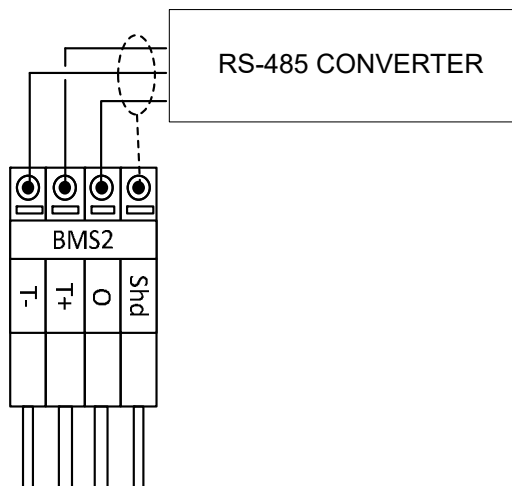

Fig. 24. ModBus connection



ModBus protocol is in English!

The following settings must be configured in the ModBus menu:

Installation menu → Configuration → Remote Control → BMS Configuration

- **Protocol** → MB Extended (default)
 - The heat pump is a slave device in the ModBus network
 - MB Master
 - MB Slave
- **Baud rate** → 19200 (default)
 - 9600
 - 4800
 - 2400
 - 1200
- **Stop bits** → 2 (default)
 - 1
- **Parity** → none (default)
 - odd
 - even
- **Address** → 17 (default)
 - 1 ... 207 (Setting range)
- **Communication** → RS 485

3.3.16 ModBus protocol



Only Digital input (DI) data points (DI) can be written →see chapter 3.3.5

BMS address	Description	Read / Write	Type	Unit	Min.	Max.	Display
1	Brine temperature Out	R	Analog	°C			
2	Brine temperature In	R	Analog	°C			
3	Heating temperature Out	R	Analog	°C			
4	Heating temperature In	R	Analog	°C			
5	Compressor suction temperature	R	Analog	°C			
6	Compressor suction pressure	R	Analog	°C			
7	Compressor discharge pressure	R	Analog	°C			
8	DHW temperature	R	Analog	°C			
11	Outdoor temperature	R	Analog	°C			
13	Brine circulation pressure	R	Analog	bar			
14	Heating circulation pressure	R	Analog	bar			
29	Brine temp. Air Unit outlet	R	Analog	°C			
30	Coefficient of Performance (COP)	R	Analog	[]			
31	Seasonal Performance Factor (SPF)	R	Analog	[]			
94	Condensation temperature	R	Analog	°C			
132	Superheat	R	Analog				
133	Expansions valve position	R	Analog	%	0	100	000
134	BUS DHW Set point	R/W	Analog	°C			
135	BUS Heating DG1 Set point	R/W	Analog	°C			
136	BUS Heating SG2 Set point	R/W	Analog	°C			
137	BUS Heating SG3 Set point	R/W	Analog	°C			
138	BUS Heating SG4 Set point	R/W	Analog	°C			
139	BUS Cooling DG1 Set point	R/W	Analog	°C			
140	BUS Cooling SG2 Set point	R/W	Analog	°C			
141	BUS Cooling SG3 Set point	R/W	Analog	°C			
142	BUS Cooling SG4 Set point	R/W	Analog	°C			
143	BUS Pool Set point	R/W	Analog	°C			
194	Supply temperature SG3	R	Analog	°C			
195	Supply temperature SG3	R	Analog	°C			
196	Supply temperature SG4	R	Analog	°C			
198	Start temperature for DHW	R	Analog	°C			
199	Evaporation temperature	R	Analog	°C			
200	Heating buffer tank temperature	R	Analog	°C			
201	Cooling buffer tank temperature	R	Analog	°C			
202	EER	R	Analog				
203	Compressor discharge temperature	R	Analog	°C			

BMS address	Description	Read / Write	Type	Unit	Min.	Max.	Display
1	Compressor rpm	R	Integer	min. ⁻¹			
3	Scroll Temperature	R	Integer	°C			
4	Inverter temperature	R	Integer	°C			
79	Working Hours L	R	Integer	h	0	999	000
80	Working Hours H * 1000	R	Integer	h	0	999	000
81	Current Power Consumption	R	Integer	W			
82	Current Condensation capacity	R	Integer	W			
92	Current hour	R	Integer	hour	0	23	00
93	Current minute	R	Integer	min	0	59	00
94	Current_day	R	Integer	day	1	31	00
95	Current_month	R	Integer	month	1	12	00
96	Current_year	R	Integer	year	0	99	00
143	Condensation energy January	R	Integer	kWh			0
144	Condensation energy February	R	Integer	kWh			0
145	Condensation energy march	R	Integer	kWh			0
146	Condensation energy April	R	Integer	kWh			0
147	Condensation energy May	R	Integer	kWh			0
148	Condensation energy June	R	Integer	kWh			0
149	Condensation energy July	R	Integer	kWh			0
150	Condensation energy August	R	Integer	kWh			0
151	Condensation energy September	R	Integer	kWh			0
152	Condensation energy October	R	Integer	kWh			0
153	Condensation energy November	R	Integer	kWh			0
154	Condensation energy December	R	Integer	kWh			0
155	Evaporation energy January	R	Integer	kWh			0
156	Evaporation energy February	R	Integer	kWh			0
157	Evaporation energy March	R	Integer	kWh			0
158	Evaporation energy April	R	Integer	kWh			0
159	Evaporation energy May	R	Integer	kWh			0
160	Evaporation energy June	R	Integer	kWh			0
161	Evaporation energy July	R	Integer	kWh			0
162	Evaporation energy August	R	Integer	kWh			0
163	Evaporation energy September	R	Integer	kWh			0
164	Evaporation energy October	R	Integer	kWh			0
165	Evaporation energy November	R	Integer	kWh			0
166	Evaporation energy December	R	Integer	kWh			0
167	Electrical consumption January	R	Integer	kWh			0
168	Electrical consumption February	R	Integer	kWh			0
169	Electrical consumption March	R	Integer	kWh			0
170	Electrical consumption April	R	Integer	kWh			0

BMS address	Description	Read / Write	Type	Unit	Min.	Max.	Display
171	Electrical consumption May	R	Integer	kWh			0
172	Electrical consumption June	R	Integer	kWh			0
173	Electrical consumption July	R	Integer	kWh			0
174	Electrical consumption August	R	Integer	kWh			0
175	Electrical consumption September	R	Integer	kWh			0
176	Electrical consumption October	R	Integer	kWh			0
177	Electrical consumption November	R	Integer	kWh			0
178	Electrical consumption December	R	Integer	kWh			0
184	Evaporation capacity	R	Integer	W			0
220	Working program by BUS	R/W	Integer				
221	BUS DHW Demand	R/W	Integer				
222	BUS Pool Demand	R/W	Integer				
223	BUS DG1 Demand	R/W	Integer				
224	BUS SG2 Demand	R/W	Integer				
225	BUS SG3 Demand	R/W	Integer				
226	BUS SG4 Demand	R/W	Integer				
280	Number of Starts L	R	Integer				
281	Number of Starts H	R	Integer				
284	Software version 1	R	Integer	[]	0	99	
285	Software version 2	R	Integer	[]	0	99	
286	Software version 3	R	Integer	[]	0	99	
50	Alarm: 1= No alarm 0=Active alarm	R	Boolean	[]	0	1	0
53	On/off control by BUS	R/W	Boolean				
127	Summer	R	Boolean				
128	Winter	R	Boolean				

Type of data		
I	Integer	Register
A	Analog	Register/10
B	Boolean	Coil

3.3.17 Wiring of the electric heater of the hot water heater

The boiler electric heater is pre-connected to a heating capacity of 2 kW. It must be rewired accordingly to achieve higher heating capacity. (External wiring is given in chapter 3.3.2)

Electric heater	KDW 1-6 (for heat pumps and solar water heaters)
Heating elements	3 x 2.0 kW
	3 x 80 ohms

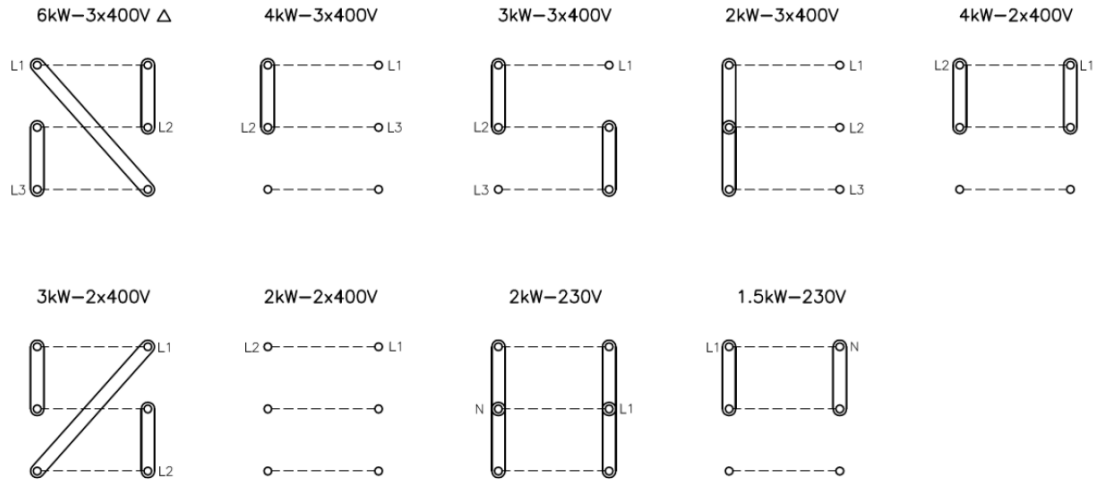

Fig. 25. Electrical heater wiring in the boiler



Detailed information is attached to the product or is listed in the technical data sheet.



Electrical installation must be carried out in accordance with local regulations.

3.3.18 Cable cross-sections



External wiring must always comply with local regulations.

Our recommendation:

Connection 3 x 400V	Min.	Recommended
WP 3 x 400V, 3L / N / PE	5 x 2.5 mm ²	5 x 2.5 mm ²
Boiler 3 x 400V, 3L / N / PE	4 x 2.5 mm ²	4 x 2.5 mm ²
Emergency heating 3 x 400 V, 3L/ N / PE	5 x 2.5 mm ²	5 x 2.5 mm ²
Wiring in room control unit thT, with shielding	4 x 0.5 mm ²	4 x 0.75 mm ²
ComfoAir control unit wiring, including shielding	4 x 0.5 mm ²	4 x 0.75 mm ²
Temperature sensor	2 x 0.5 mm ²	2 x 0.75 mm ²
External pumps 230V	3 x 1.5 mm ²	3 x 1.5 mm ²
External mixing or switching valves 230V	3 x 1.5 mm ²	3 x 1.5 mm ²

3.3.19 ComfoAir electrical connection



The power supply of the ventilation unit must be connected to the heat pump's electrical module by an electrician.

The electrical connection can be made directly to the 230V socket or the power module can be connected to the power supply. In addition, the electric module has a connector for connection to ComfoNet. This allows you to connect external ComfoNet devices directly or via an electrical module. The ventilation unit is operated autonomously.

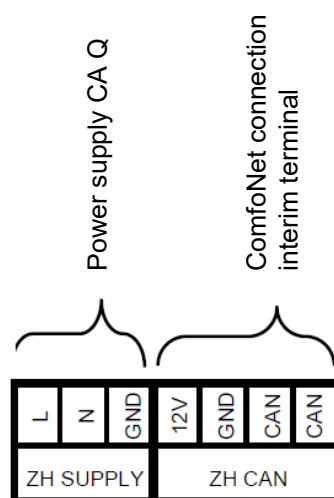
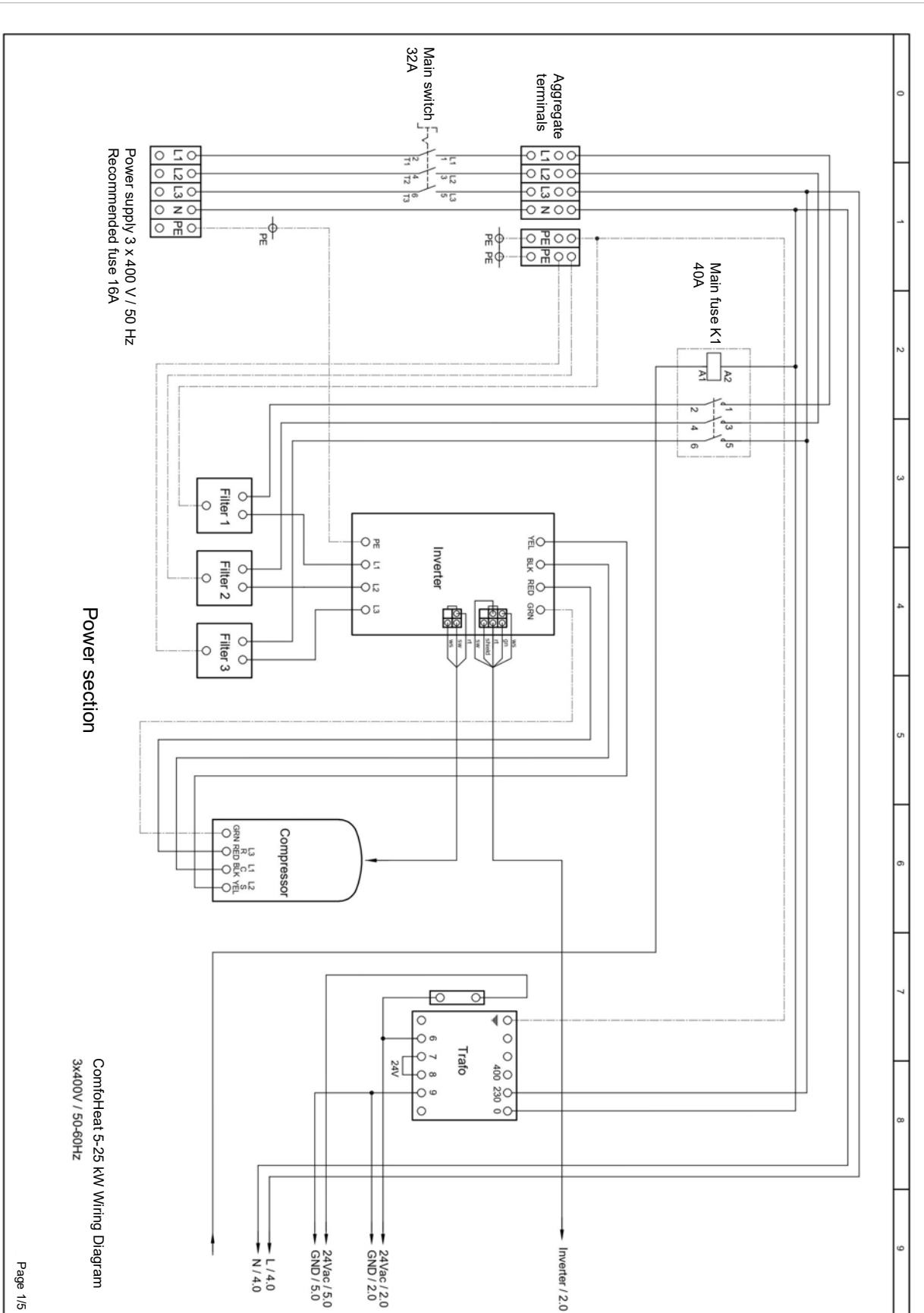
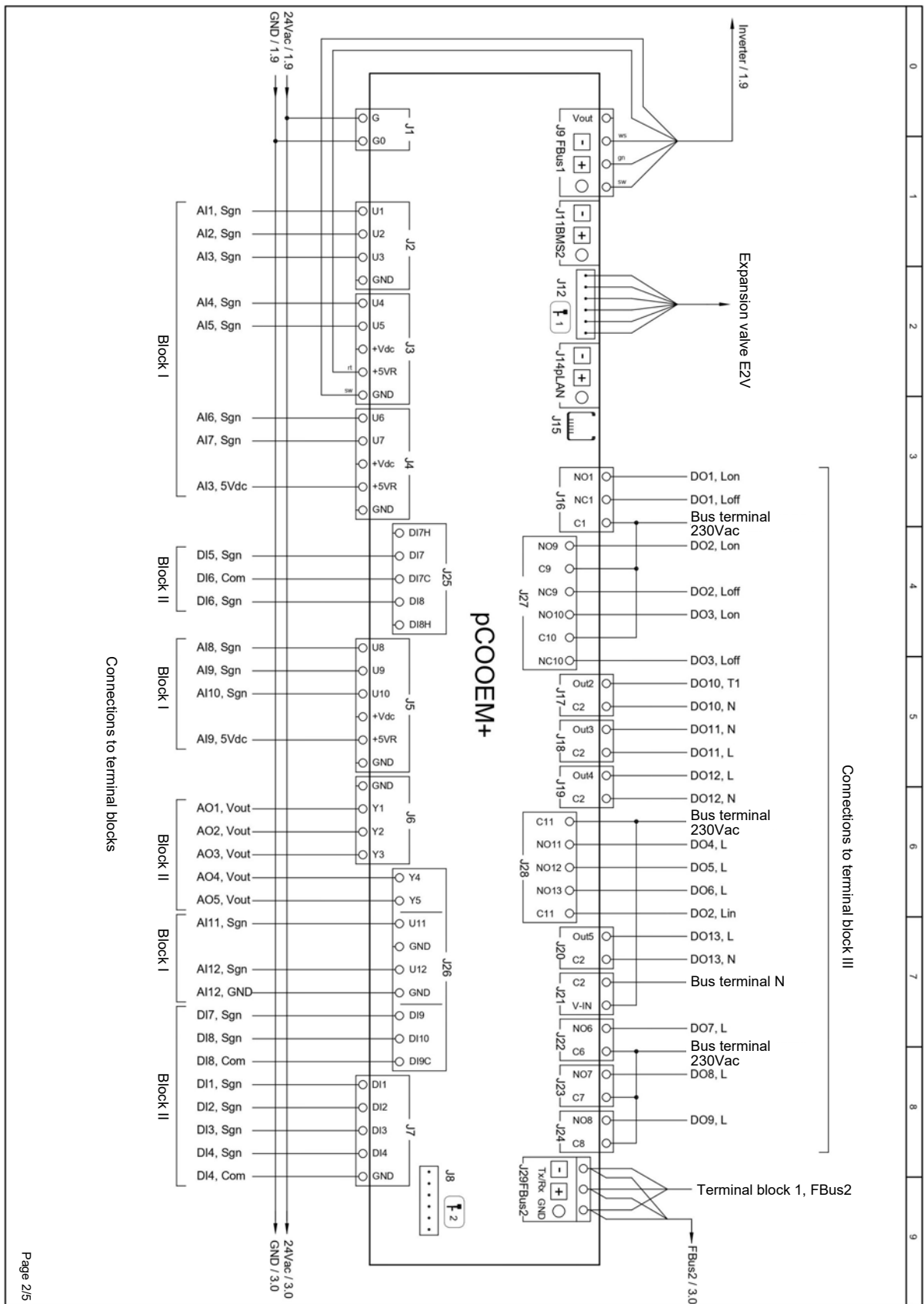
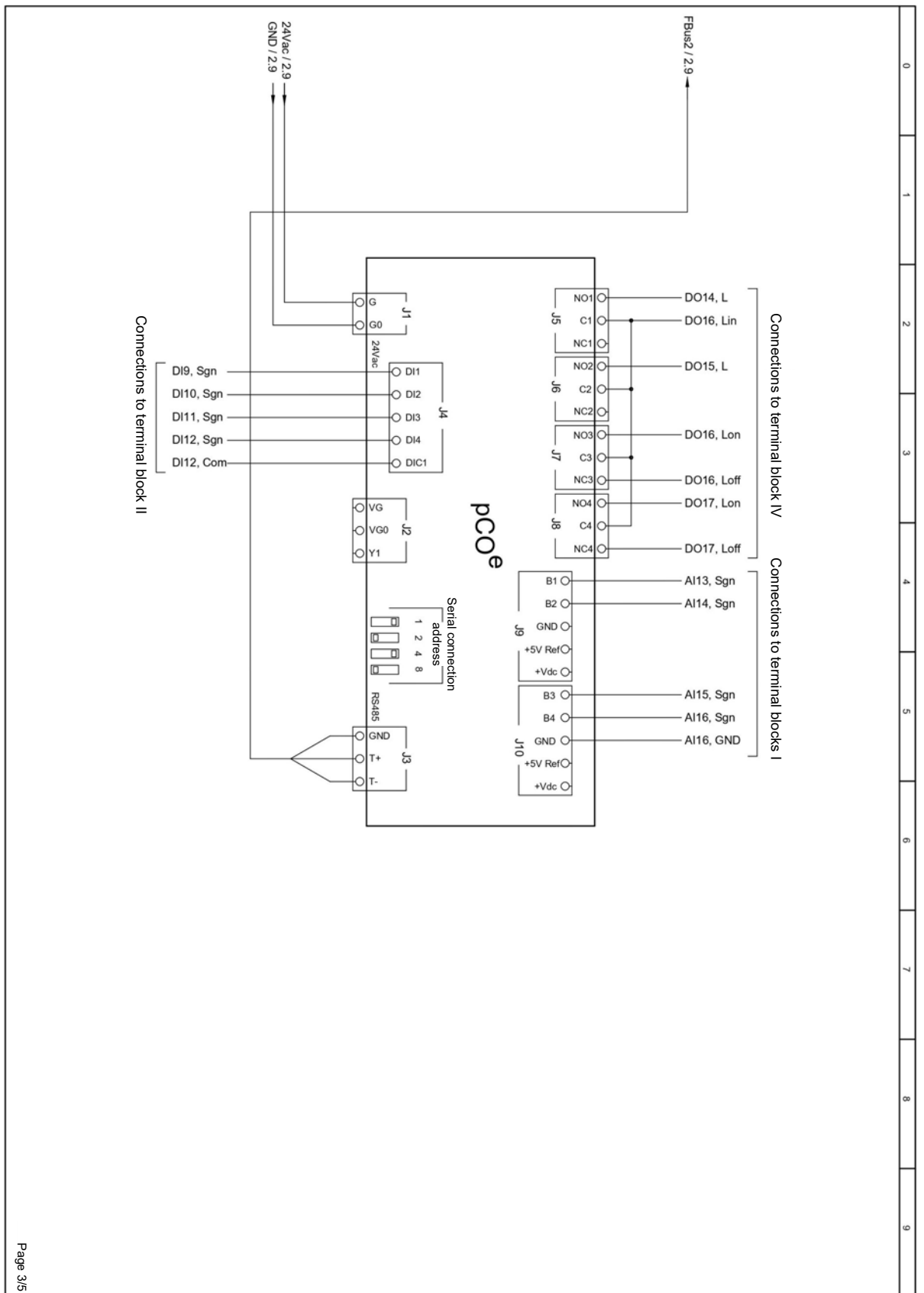

Fig. 26. Connection terminals of ComfoAir power module

3.4 Wiring diagram







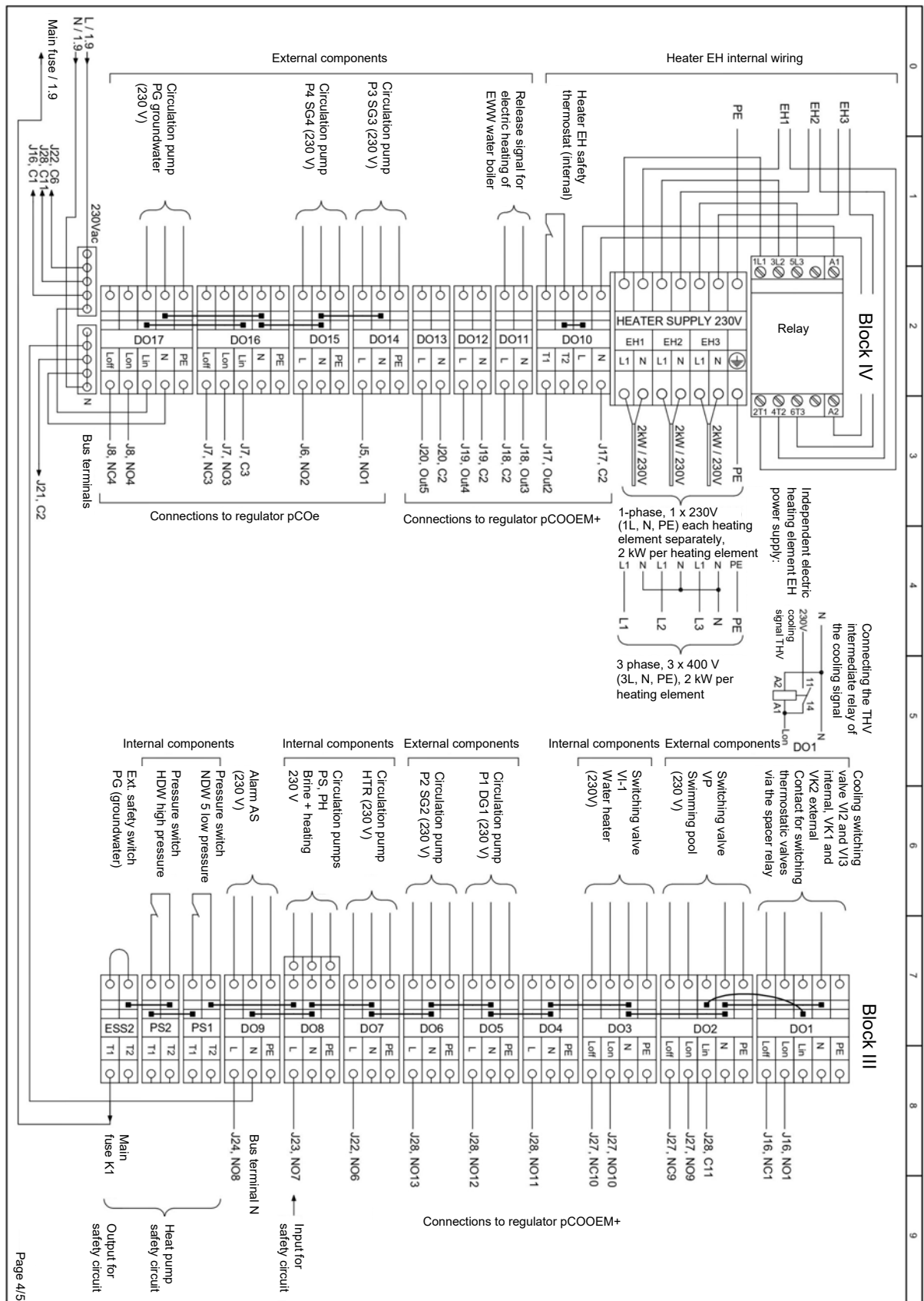

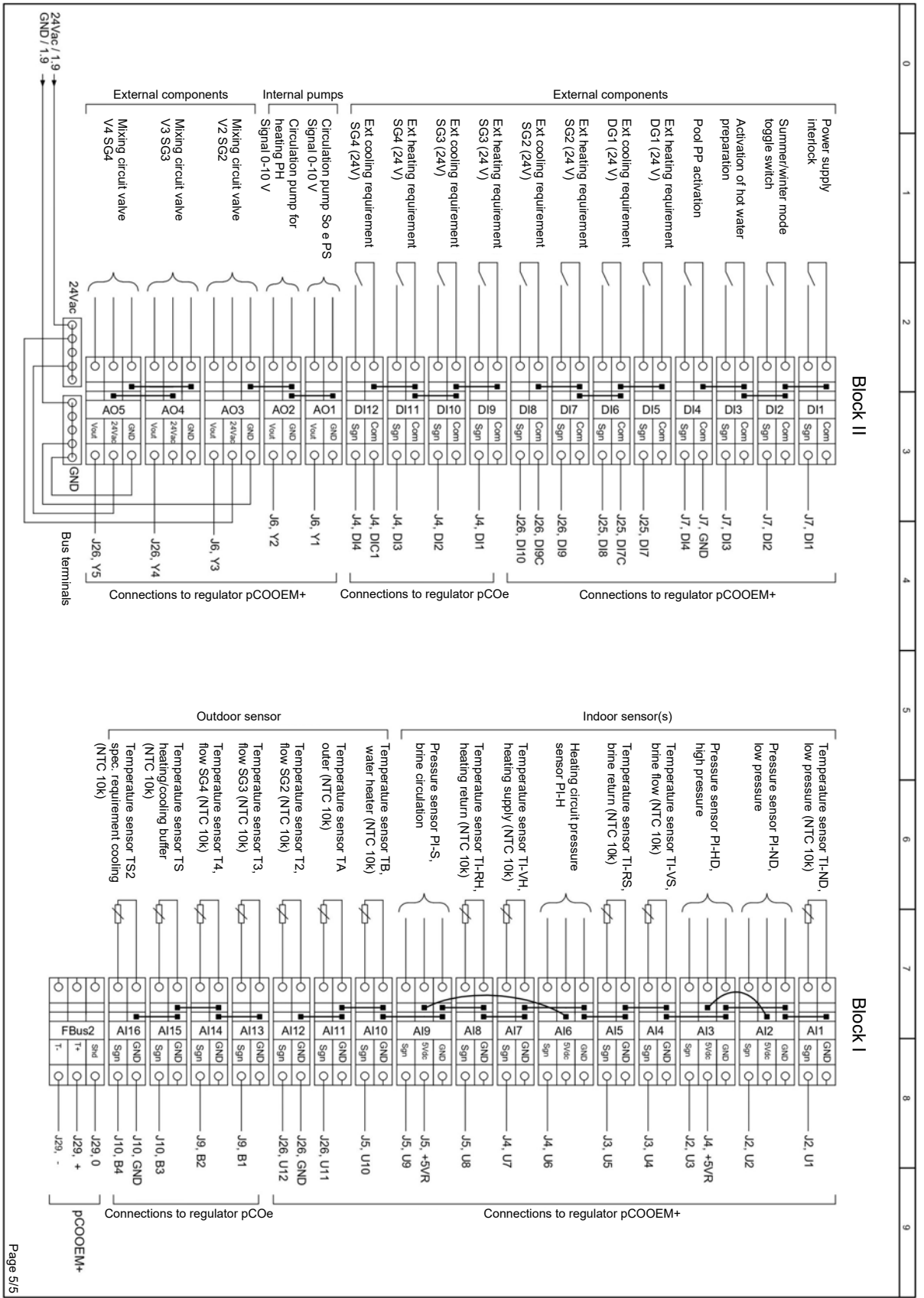

3.5 Connecting to air pipes

Air pipes must be installed so that there is as little resistance as possible and airtight. To prevent condensation, the external air and exhaust ducts between the device and the bushings must be isolated in a vapour-diffusion-proof manner. If the appliance is in an unheated room, the inlet and outlet ducts between the appliance and the air distribution system shall also be insulated. We recommend using the Zehnder ComfoPipe Compact 200 Pipe System to connect the intake and exhaust air, and the Zehnder ComfoPipe Plus 200 Pipe System to connect the external and exhaust air.

The inner diameter of the pipes to be connected shall be at least 180 mm.

3.5.1 Dimensioning air pipes

• Outside air inlet	0.2 m/s	Recommended
• Outside air passageway in mist accumulation areas	1.5 m/s	Recommended
• Pipe into and out of individual rooms	2.5 m/s	Recommended
• 100-1000 m ³ /h	max. 3 m/s	Regulation

3.5.2 ComfoAir Q450 power chart

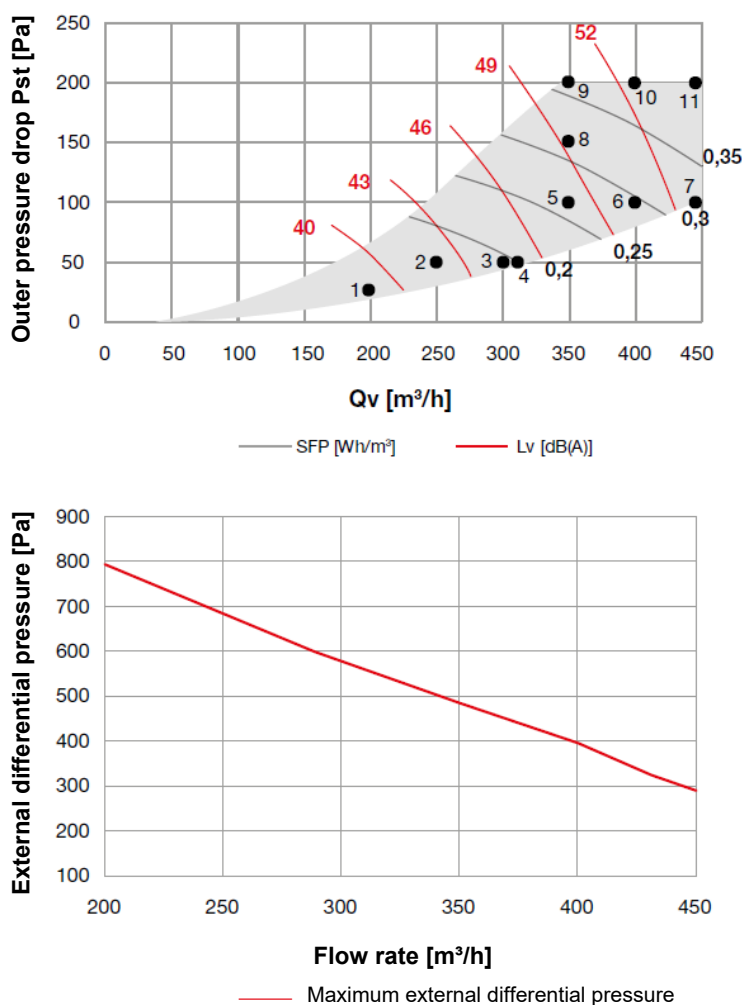

Fig. 27. ComfoAir Q450 flow characteristics

ComfoFond Q-Box reduces the maximum air volume of the ventilation unit by approximately 100 m³/h.

3.5.3 ComfoAir Q600 power chart

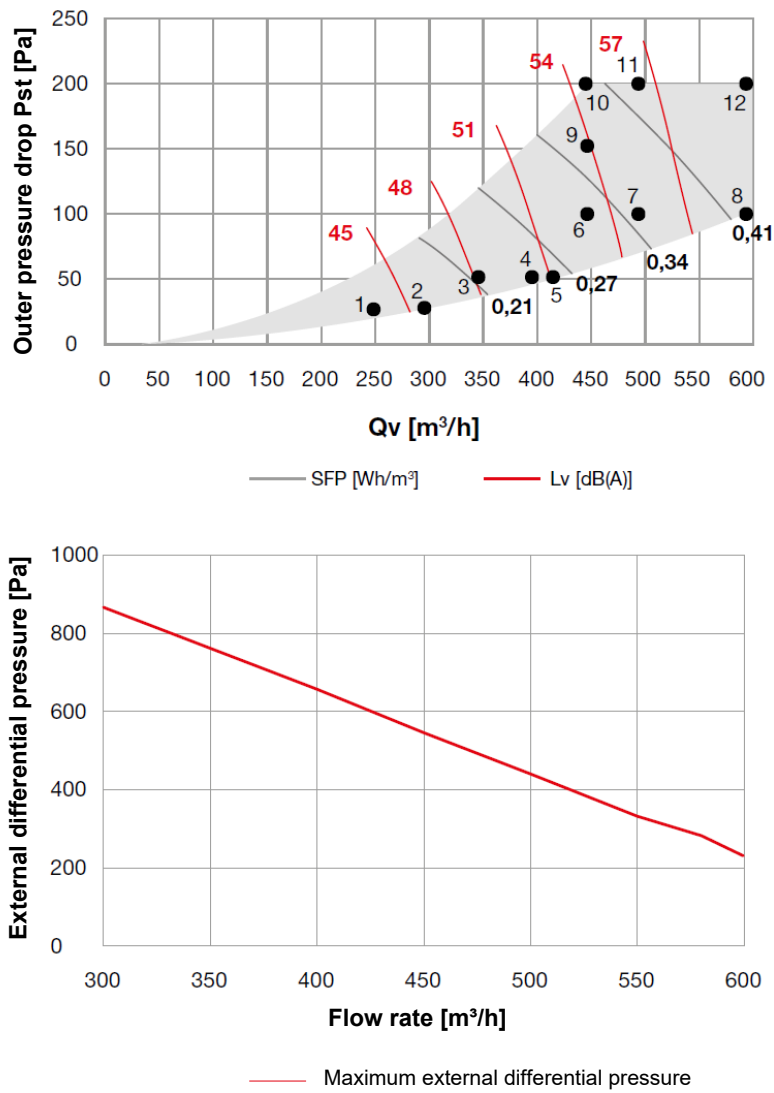

Fig. 28. ComfoAir Q600 flow characteristics

ComfoFond Q-Box reduces the maximum air volume of the ventilation unit by approximately 100 m³/h.

4 Specifications

4.1 Zehnder ComfoBox Q specifications

Zehnder ComfoBox Q	ComfoBox Q 1-9	ComfoBox Q 3-12	
Efficiency			
Heat pump energy efficiency class / efficiency VL35 °C	A+++ / 195	A+++ / 195	%
Power ratings	Modulating/inverter	Modulating/inverter	
Application			
Heating	YES	YES	
Water heating	YES	YES	
Electrically integrated emergency heating	YES	YES	
Weekly el. legionella protection 2-6 kW	YES	YES	
Passive cooling via heat dissipation	YES	YES	
Ambient air preconditioning (ComfoFond Q-Box)	YES	YES	
Power data			
Compressor adjustment range	25 to 100	25 to 100	%
Heating capacity B0/W35	2.8-11	4.0-16	kW
Power Factor COP ¹ (B0/W35 °C)	4.5	4.6	
Maximum flow temperature	60	60	°C
Sound power level ²	33-44	34-45	dB(A)
Output power of the ground probe			
without ComfoFond Q-Box (B0/W35 °C)	2.2 - 8.3	3.1 - 11.7	kW
with ComfoFond Q-Box ³ (B0/W35 °C)	3.2 - 9.3	4.1 - 12.7	kW
Heat pump electrical data			
Compressor operating voltage: 3P / N / PE / 50Hz / 400V	3 x 400	3 x 400	V
Recommended fuse 3P / N / PE / 50Hz / 400V	3 x 10	3 x 16	A
Power consumption of the compressor on switching on	0.9 - 1.9	0.7 - 2.6	A
Max. working current WP (B0/W35 °C)	4	6.2	A
Max. working current WP (B0/W55 °C)	5.5	7.2	A
Number of compressors	1	1	Pcs
Frequency changer	YES	YES	
Number of starts per hour	max. 3 (20 min.)	max. 3 (20 min.)	
Start delay after power failure	1	1	min.
Emergency heating electrical data			
Emergency heating working voltage: 3P / N / PE / 50Hz / 400V	3 x 400	3 x 400	V
Recommended fuse 1P / N / PE / 50Hz / 230V	16	16	A
Zehnder ComfoAir Q electrical data			
Operating voltage: 1P / N / PE / 50Hz / 230V	1 x 230	1 x 230	V
Recommended fuse 1P / N / PE / 50Hz / 230V	10	10	A
Freezing agent			
Type	R410A	R410A	
Amount	0.8	0.9	kg
Dimensions			
Height x Width x Depth	1914 x 922 x 643	1914 x 922 x 643	mm
Weight without packaging	230	240	kg
Brine circuit			
Min. / max. temperature	-10 / 20	-10 / 20	°C
Max. operating pressure	3	3	bar
Nominal flow rate	285-2628	918-2976	kg/h
Recommended freezing agent	Propylene glycol/water with a freezing point of -17°C ±2°C		
Heat circuit			
Min. / max. temperature	20 / 60	20 / 60	°C
Max. operating pressure	3	3	bar
Nominal flow rate	224-1892	361-2751	kg/h
Heating water quality	SWKI Directive BT 102-01, EN 14868 and SIA 384/1		

¹ According to EN 14511 including consumption of circulation pumps and compression drives

² According to EN 12102, including sound insulation of the compressor

4.2 ComfoBox Q 1-9 power charts

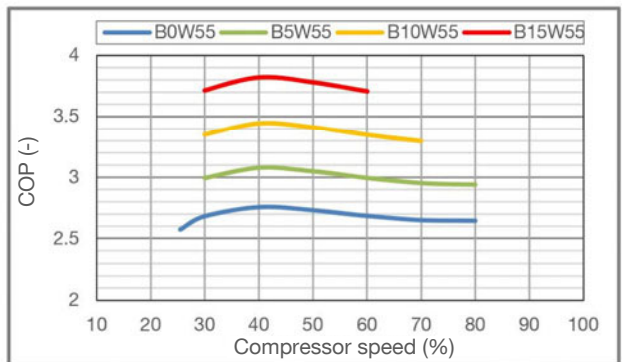
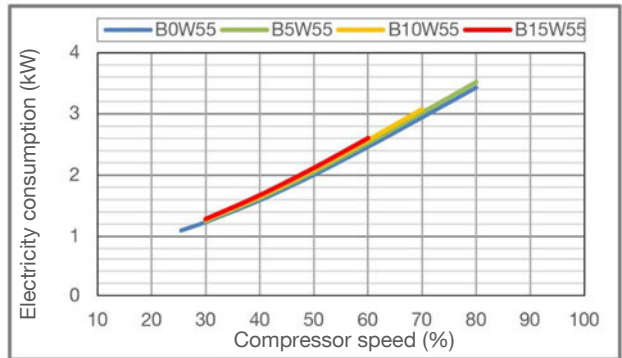
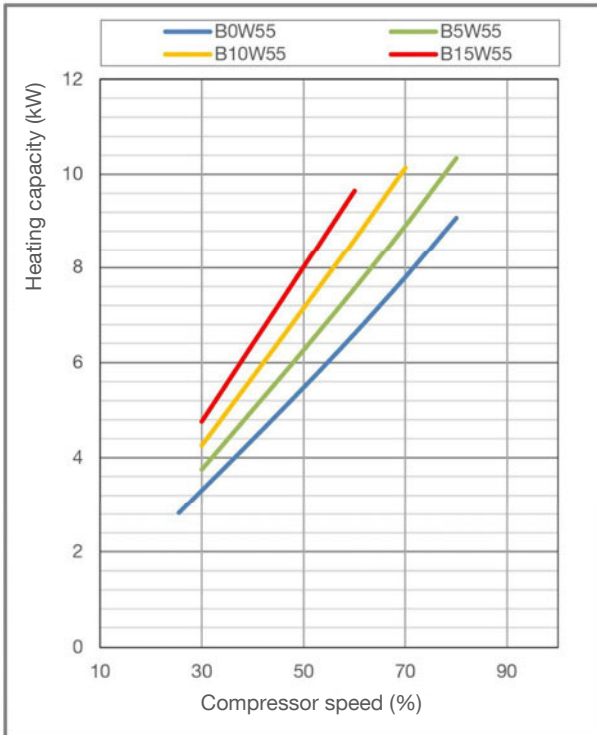
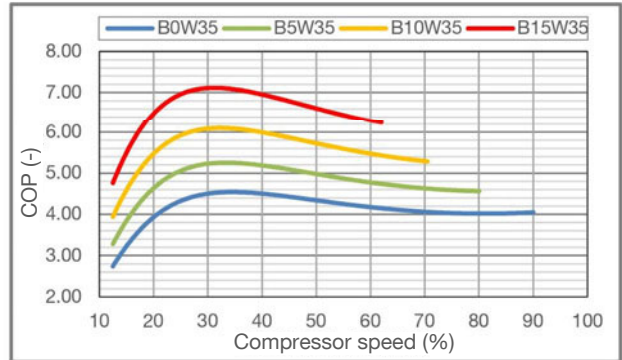
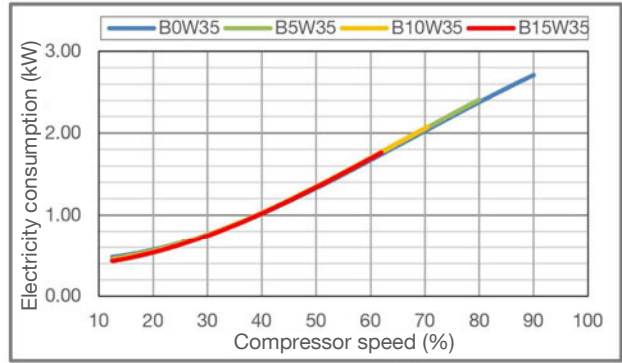
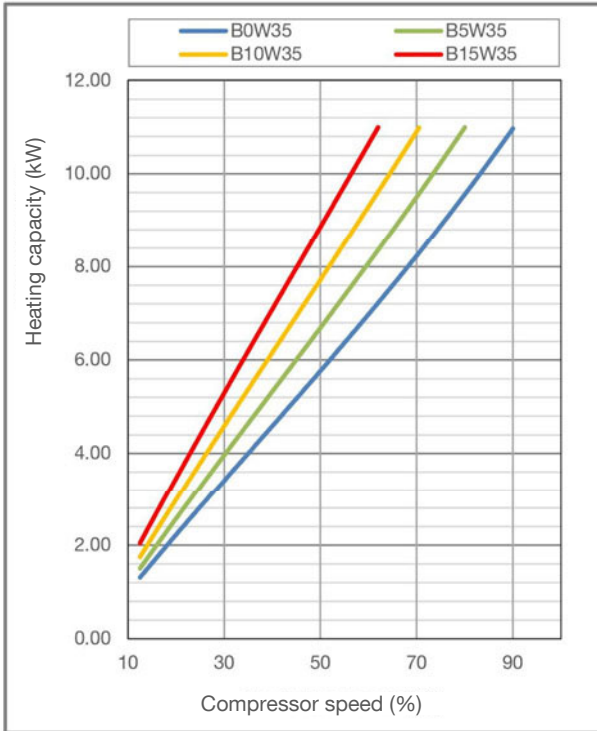

4.3 ComfoBox Q 3-12 power chart

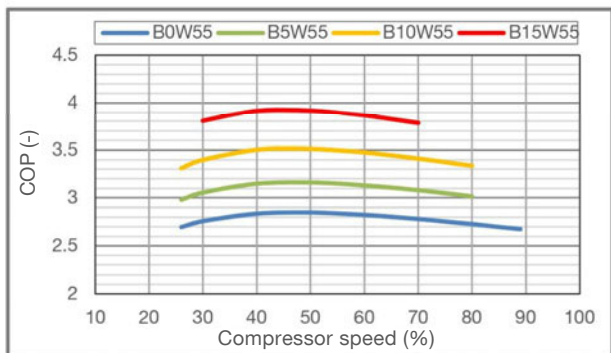
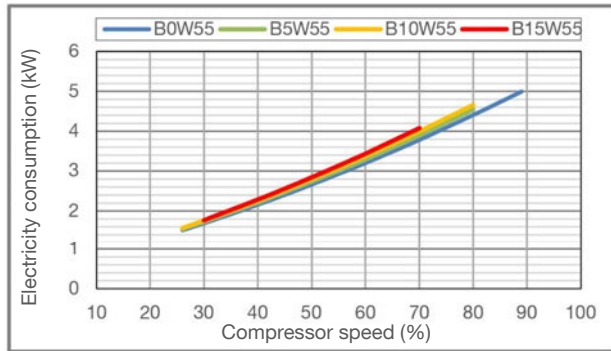
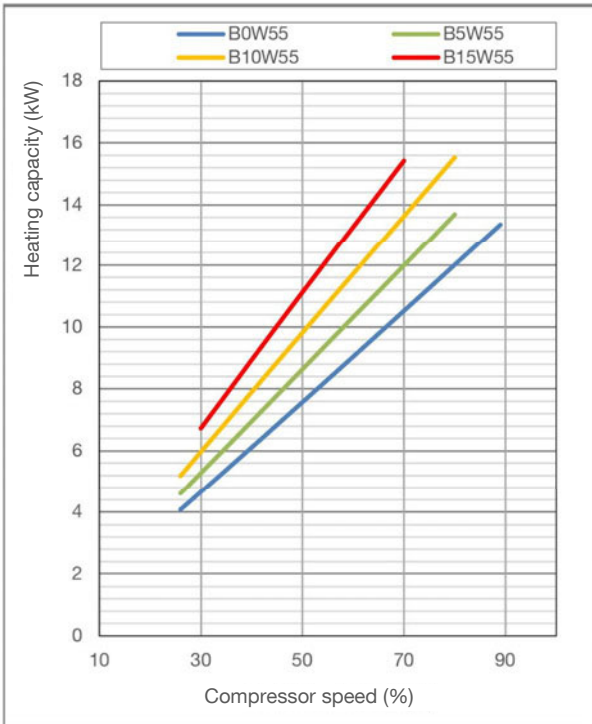
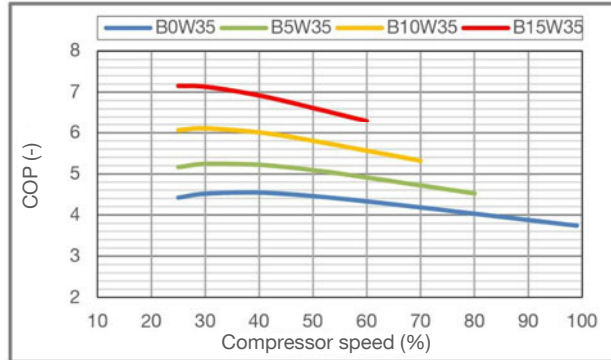
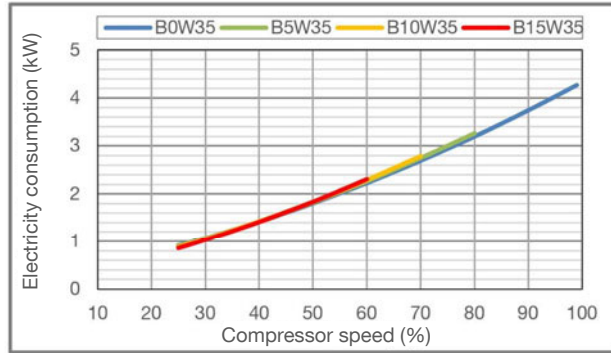
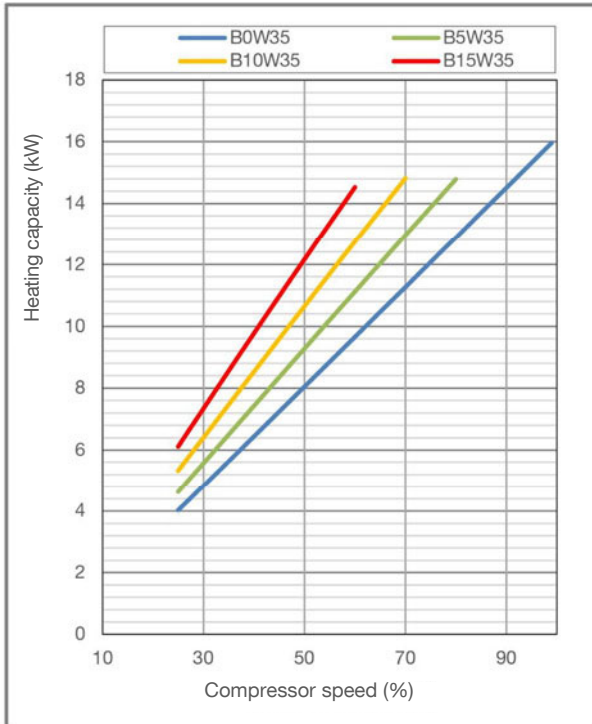

4.4 ComfoBox Q 1-9 pressure loss table

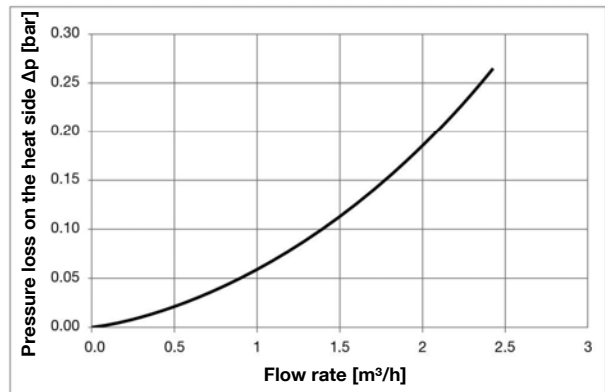
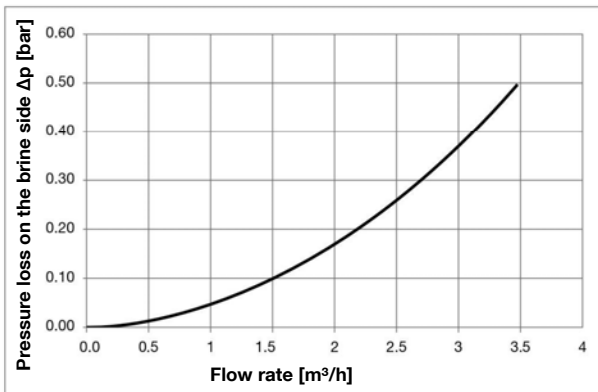
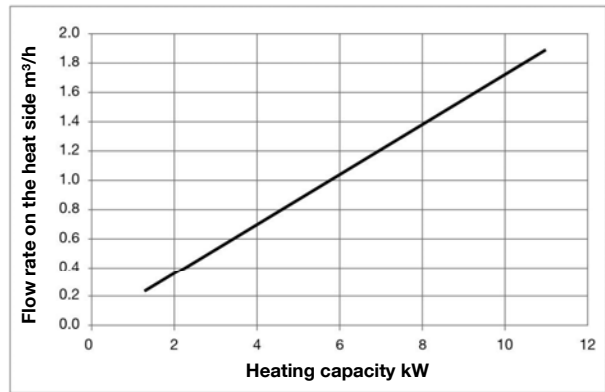
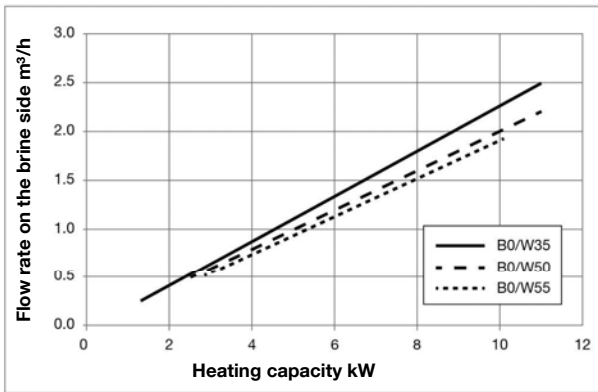

4.5 ComfoBox Q 3-12 pressure loss table

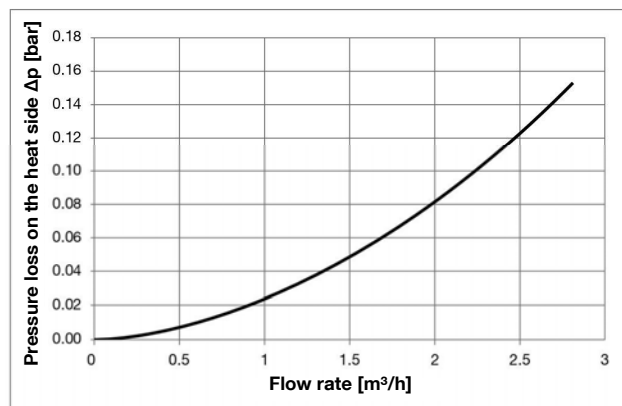
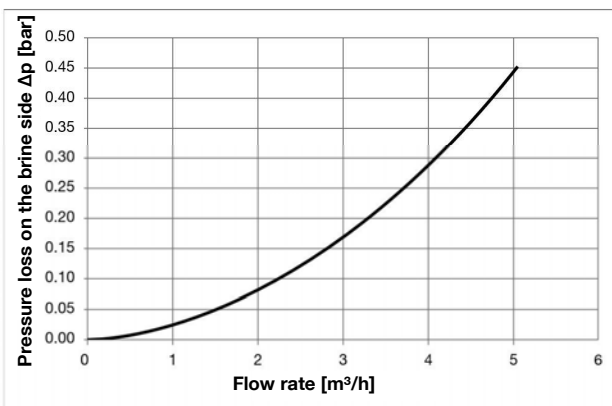
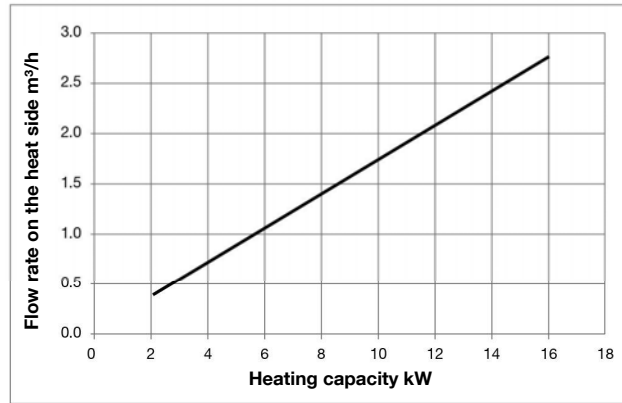
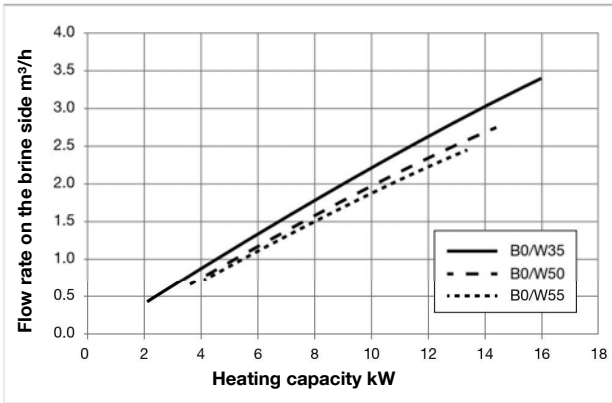

5 ComfoBox integration concept

5.1 General information on integration options



The parts of the diagrams marked in such a way are included in the ComfoBox or in the delivery package.

- The integration options presented on the following pages are conceptual diagrams. Installation of the system must be in accordance with local building codes, local government and energy supplier regulations and technical regulations.

5.2.2 Option 1 with swimming pool option

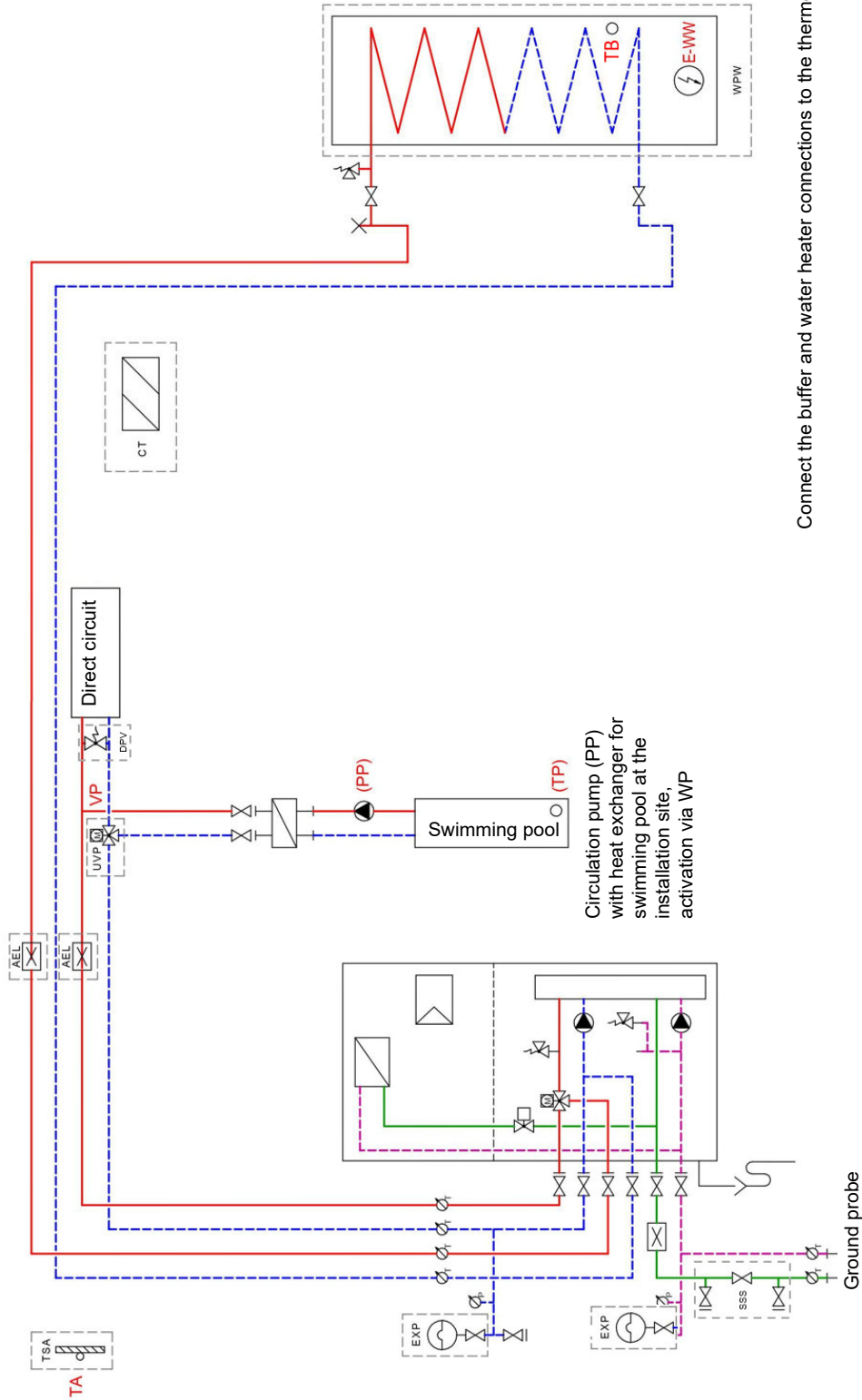

Connect the buffer and water heater connections to the thermosiphon

For abbreviations and symbols see last page

5.2.3 Option 1 with solar option

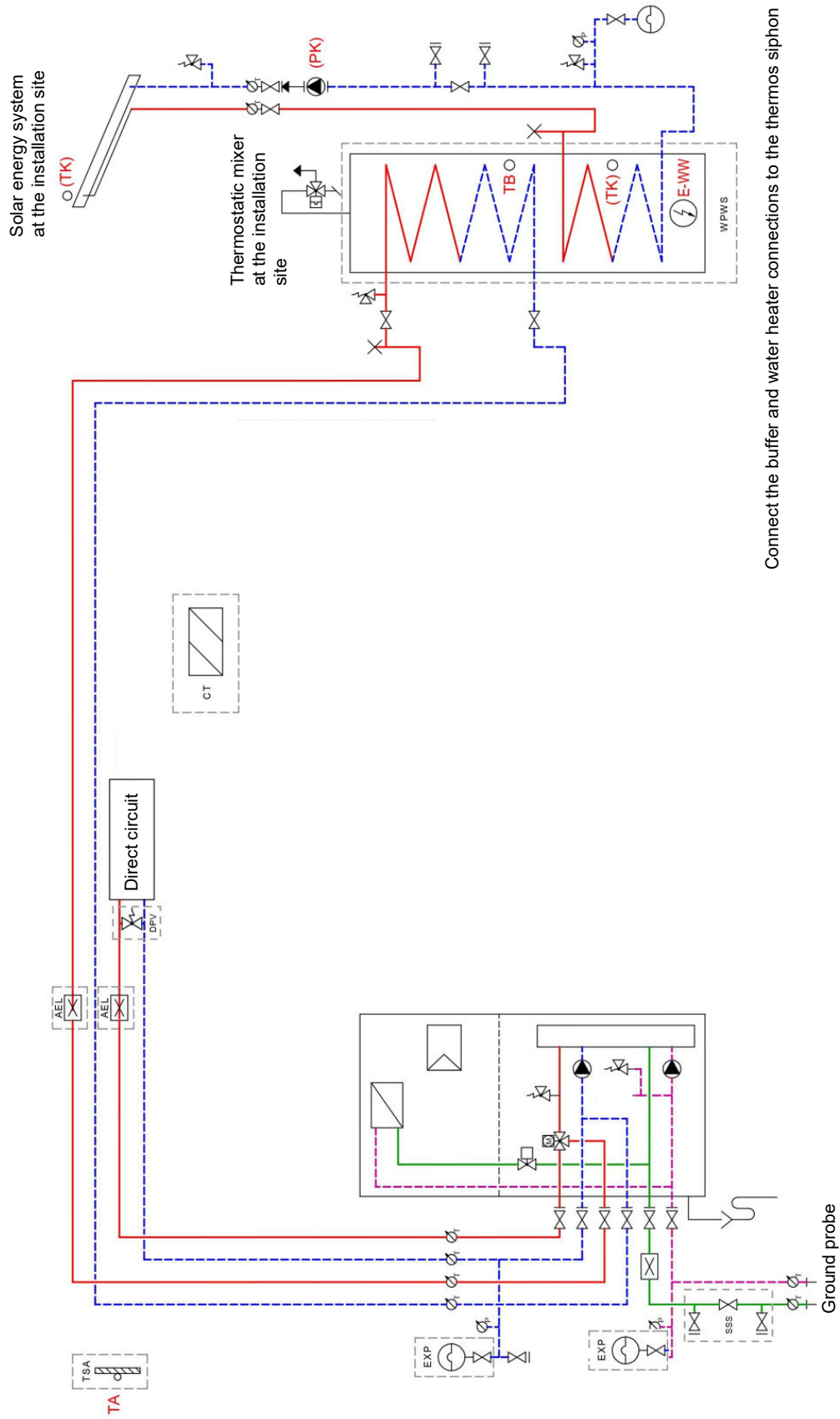

For abbreviations and symbols see last page

5.3 Option 2 (direct circuit, mixing circuit with buffer tank)

5.3.1 Option 2

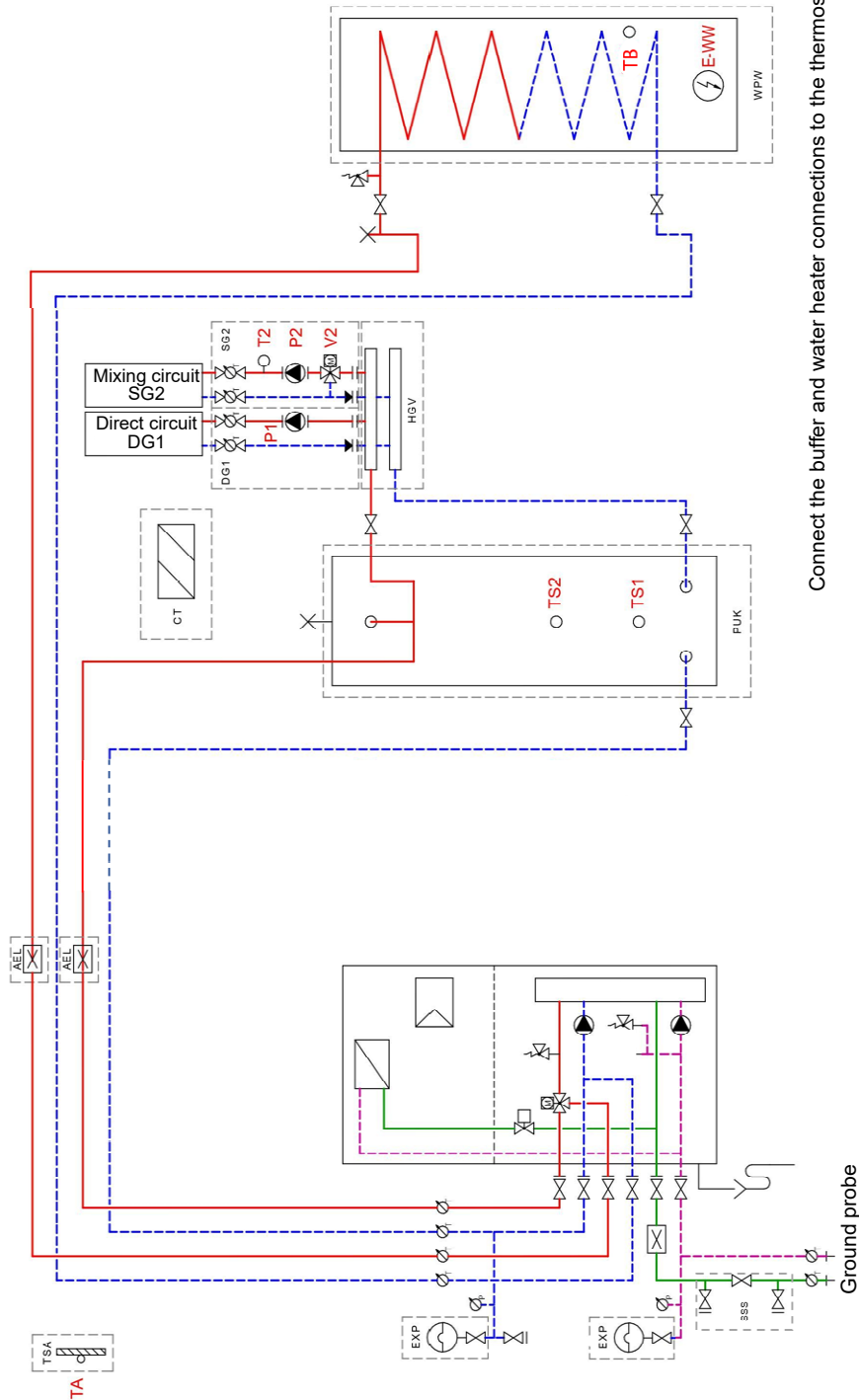

Connect the buffer and water heater connections to the thermosiphon

Abbreviations and symbols see last page

5.3.2 Option 2 with swimming pool option

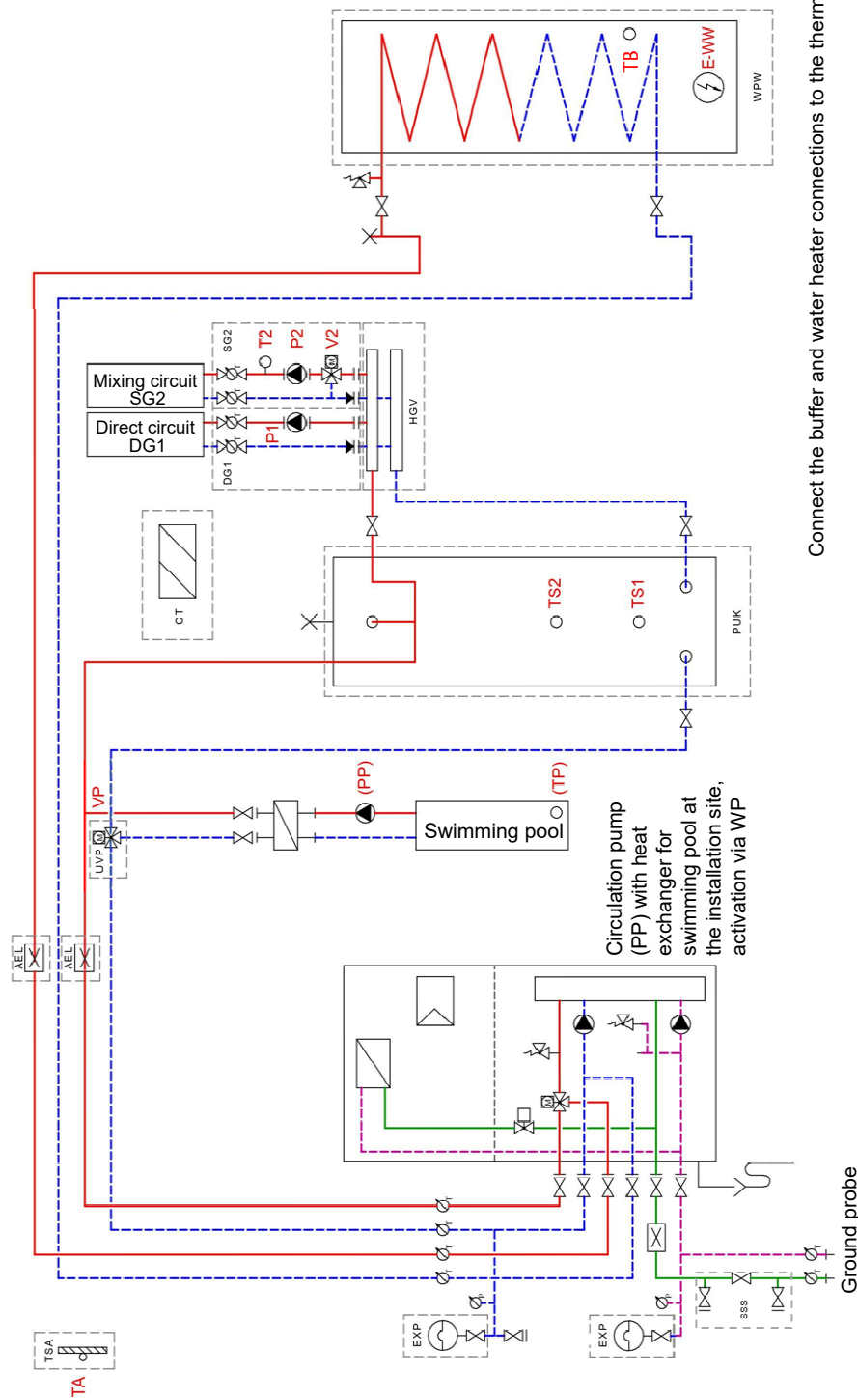

Connect the buffer and water heater connections to the thermosiphon

For abbreviations and symbols see last page

5.3.3 Option 2 with solar option

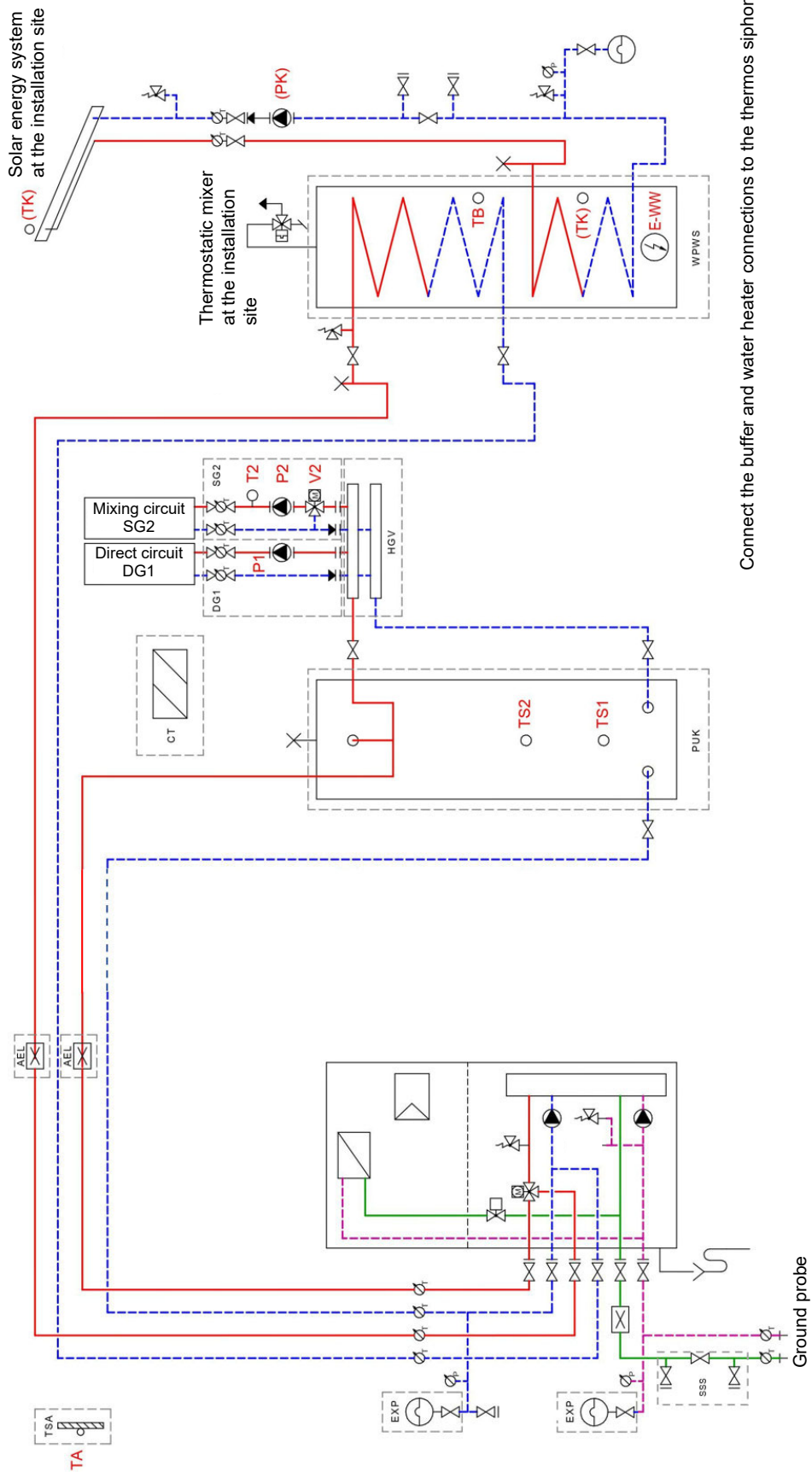

Connect the buffer and water heater connections to the thermosiphon

For abbreviations and symbols see last page

5.4 Option 3 (mixing circuit with hygiene container)

5.4.1 Option 3

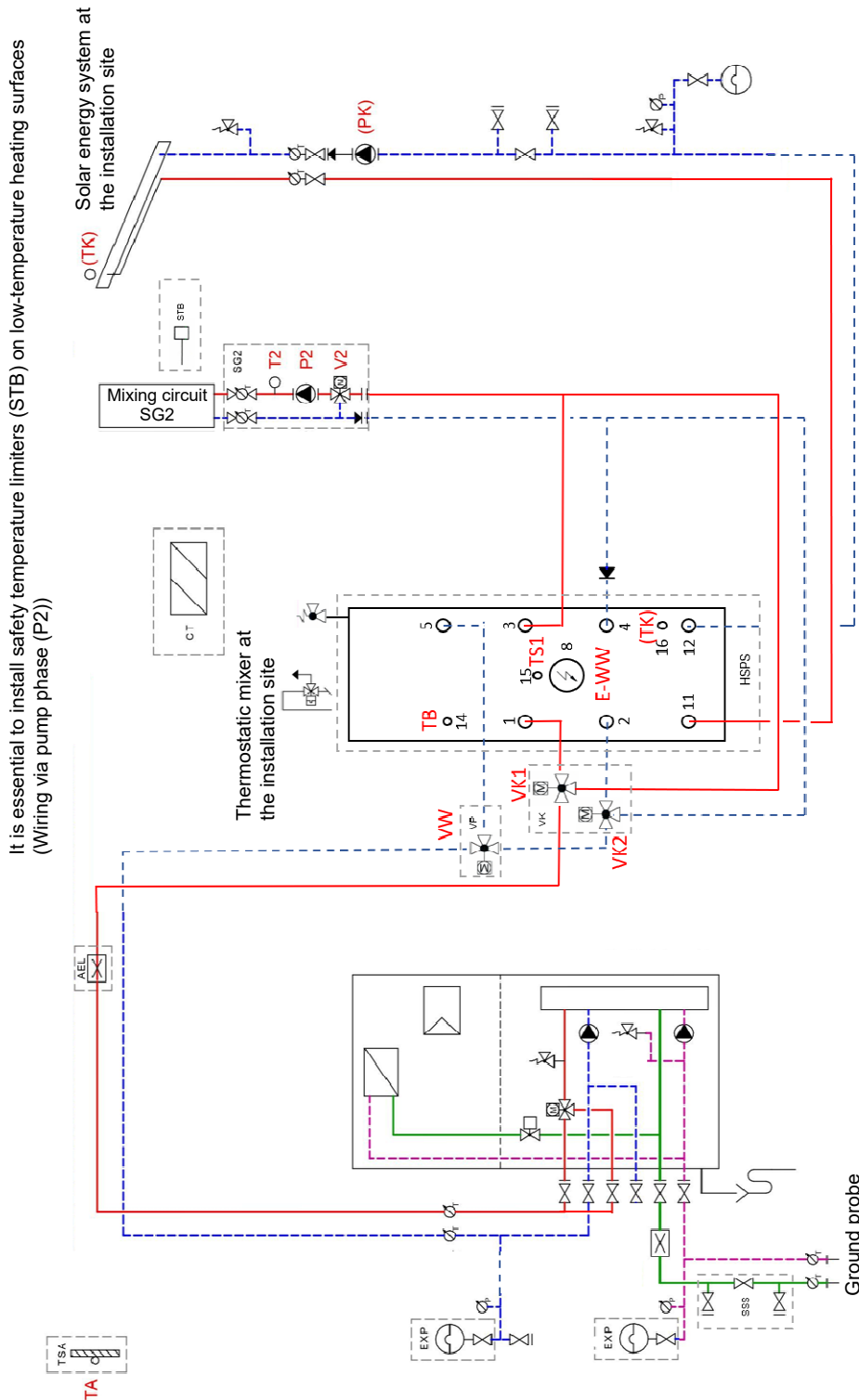























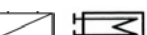

Hygiene reservoir: cooling pool rotation with two additional switching valves and non-return valve is mandatory

For abbreviations and symbols see last page







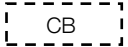
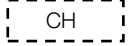
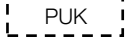
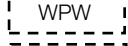
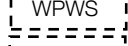
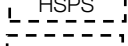
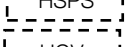
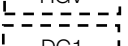
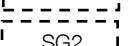
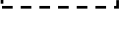

Notes

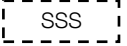
A large grid of graph paper for taking notes, consisting of 20 columns and 30 rows of small squares.

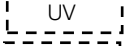
Abbreviations and symbols used

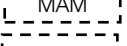
	Switch-off device	TA	External temperature sensor
	Return circuit breaker	TB	Water heater temperature sensor
	Safety Valve	T2	Mixing circuit flow temperature sensor SG2
	Excess flow valve	T3	Mixing circuit flow temperature sensor SG3
	Triple valve	T4	Mixing circuit flow temperature sensor SG4
	Thermal stirrer	TS	Reservoir temperature sensor
	Pump	TS2	Reservoir temperature sensor (cooling)
	Compressor	P1	Direct circuit circulation pump DG1
	Fan operation	P2	Mixing circuit circulation pump SG2
	Drain valve	P3	Mixing circuit circulation pump SG3
	Thermometer	P4	Mixing circuit circulation pump SG4
	Manometer	V2	Mixing circuit valve SG2
	Thermostat	V3	Mixing circuit valve SG3
	Thermocouple	V4	Mixing circuit valve SG4
	Control unit	VP	Swimming pool changeover valve
	Electrical current	VW	Hot water switching valve (option 3)
	Ventilation	VK1	Cooling bypass switching valve 1
	Heat exchanger	VK2	Cooling bypass switching valve 2
	Hose connection	E-WW	Electric heater for hot water
	Screw joint	(PG)	Groundwater circulation pump
	Siphon drain	(PP)	Swimming pool circulation pump
	Heating flow (red)	(PK)	Manifold circulation pump
	Heating return (blue)	(TP)	Swimming pool temperature sensor
	Brine flow (purple)	(TK)	Manifold temperature sensor
	Brine return (green)	(TK)	Solar water heater temperature sensor

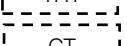
	ComfoBox
	ComfoHeat
	Freeze-insulated buffer tank
	WP water heater
	Solar HP water heater
	Hygienic container
	Hygienic container for solar energy
	Heating group divider
	Direct circuit group
	Mixing circuit group

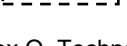
	Hose connector kit
	Brine rinse kit
	Expansion tank
	Selector valve
	Excess flow valve
	Manometer
	Automatic deaeration
	Room control console
	ComfoTherm
	Safety temperature limiter

